Electromechanical sensors for pressure control OsiSense XM

Catalogue



Simply easy!™

Selection guide pages 2 to 5

- **General** pages 6 to 11
- **Operating curves** pages 12 to 15

Electromechanical pressure and vacuum switches for control circuits

For controlling the pressure of air, water, hydraulic oils, corrosive fluids and viscous products

- **Presentation and setting** page 16
- **Characteristics** page 17
- **References**
 - Pressure and vacuum switches XMLA, B, C and D pages 18 to 67
 - Accessories and replacement parts page 68
 - Dimensions pages 69 to 71
 - Components materials of units in contact with fluid pages 72 and 73

For controlling the pressure of air, water, hydraulic oils and corrosive fluids

- **Presentation and setting** page 74
- **Characteristics** page 75
- **References**
 - OsiSense ACW, sizes from: 0.7 to 131 bar pages 76 and 77
 - OsiSense ADW, sizes from: 69 to 340 bar pages 78 and 79
 - Dimensions pages 80 and 81

For controlling the pressure of air and water

- **Presentation and setting** page 82
- **Characteristics** page 83
- **References**
 - OsiSense XMX and XMA, sizes from: 6 to 25 bar pages 84 and 85
 - Accessories and replacement parts page 86
 - Dimensions page 87

Electromechanical pressure switches for power circuits

For controlling the pressure of water

- **Presentation and setting** page 88
- **Characteristics** page 89
- **References**
 - OsiSense FGT, FSG and FYG pages 90 to 92
 - Dimensions page 93

For controlling the pressure of air and water

- **Presentation** page 94
- **Characteristics** page 95
- **References**
 - OsiSense XMP, IP 54, sizes from: 6 to 25 bar pages 96 to 101
 - OsiSense XMP, IP 65, sizes from: 6 to 25 bar pages 102 and 103
 - Accessories and replacement parts page 104
 - Dimensions page 105
- **Product reference index** pages 106 and 107

Electromechanical sensors for pressure control

OsiSense XM

Applications	Type of installation	Control circuits	
	Fluids controlled	Air, water, hydraulic oils, corrosive fluids, viscous products	
	Type of operation	Detection of a single threshold (fixed differential)	Regulation between 2 thresholds (adjustable differential)



Fluid characteristics	Air, fresh water, corrosive fluids, viscous products, up to 160 °C Sea water, up to 30 °C, depending on model		
Sizes	- 1 bar...500 bar (- 14.5 psi...7250 psi)		
Dimensions of case (mm) Width x height x depth	35 x 68 x 75	46 x 68 x 85	
Type of contacts	1 CO single-pole, snap action	2 CO single-pole, simultaneous, snap action	
Degree of protection	IP 66: switches with terminal connections IP 65: switches with connector	IP 66: switches with terminal connections	
Electrical connection	Connector : ■ EN 175301-803-A (ex-DIN 43650A), 4-pin male. Screw terminals: ■ 1 tapped entry M20 x 1.5 mm for ISO cable gland or ■ 1 tapped entry 1/2"-14 NPT for cable gland, depending on model.		
Fluid connection	G 1/4 (female) 1/4" - 18 NPTF (female) G 1 1/4" (female) for viscous products		
Type reference	XMLA	XMLB	XMLC
Pages	18 to 67		

Other versions
Electromechanical pressure and vacuum switches with alternative tapped cable entries and/or fluid entries: NPT etc. Please consult our Customer Care Centre.

Control circuits		
Air, water, hydraulic oils, corrosive fluids, viscous products	Air, hydraulic oils, corrosive fluids	
Dual stage switches Detection at each threshold (fixed differential)	Regulation between 2 thresholds (adjustable differential)	



Air, fresh water, corrosive fluids, viscous products, up to 160 °C Sea water, up to 30 °C, depending on model	Air, oils and other non corrosive fluids (- 73...+ 125 °C)	Oils and other fluids (- 25...+ 120 °C) Only oils, including synthetic oils, (- 30...+ 125 °C), depending on model
- 1 bar...500 bar (- 14.5 psi...7250 psi)	0.7 bar...131 bar (10.15 psi...1900 psi)	69 bar...340 bar (1000 psi...4930 psi)
45 x 68 x 85	88 x 88 x 68	
2 CO single-pole, staggered, snap action	1 CO or 2 CO single-pole, snap action	
IP 66: switches with terminal connections	IP 65	
Connector : ■ EN 175301-803-A (ex-DIN 43650A), 4-pin male. Screw terminals: ■ 1 tapped entry M20 x 1.5 mm for ISO cable gland or ■ 1 tapped entry 1/2"-14 NPT for cable gland, depending on model.	Screw terminals: ■ 1 tapped entry M20 x 1.5 mm for ISO cable gland or ■ 1 tapped entry for n° 13 cable gland, depending on model	
G 1/4 (female) 1/4" - 18 NPTF (female) G 1 1/4" (female) for viscous products	G 1/4 (femelle)	G 3/8 (female)
XMLD	ACW	ADW
18 to 67	76 and 77	78 and 79

Electromechanical sensors for pressure control

OsiSense XM

Applications	Type of installation	Control circuits
	Fluids controlled	
	Type of operation	



Fluid characteristics	Air, fresh water, sea water (0...+ 70°C)	
Sizes	6 bar, 12 bar and 25 bar (87 psi, 174 psi and 362.5 psi)	
Dimensions of case (mm) Width x height x depth	57 x 78 x 97.5	
Setting of switching points	Internal screws	External screws
Type of contacts	1 CO single-pole, snap action	
Degree of protection	IP 54	
Electrical connection	Screw terminals: <ul style="list-style-type: none"> ■ 2 entries tapped for n° 13 cable gland, ■ one fitted with n° 13 cable gland, ■ one fitted with blanking plug. 	
Fluid connection	G 1/4 or 4 x G 1/4 (female), depending on model	
Type reference	XMx	XMA
Pages	84	85
Other versions	Electromechanical pressure switches with alternative tapped cable entries and/or fluid entries: ISO, NPT, etc. Please consult our Customer Care Centre.	

Power circuits			
Water			Air, water
Detection of a single threshold (fixed differential)	Regulation between 2 thresholds (adjustable differential)		



Fresh water, sea water (0...+ 70°C)			Air, fresh water, sea water (0...+ 70°C)	
4.6 bar (66.7 psi)	7 bar (101.5 psi)	10.5 bar (152.3 psi)	6 bar, 12 bar and 25 bar (87 psi, 174 psi and 362.5 psi)	
73 x 73 x 102	72 x 77 x 106	72 x 73 x 102	57 x 78 x 97.5	
Internal screws				
2 NC snap action			2 NC or 3 NC snap action	
IP 20/IP 65			IP 54 or IP 65, depending on model	
Screw terminals: <ul style="list-style-type: none"> ■ 2 cable entries with grommet or ■ 2 cable entries with n° 13 cable gland 			Screw terminals: <ul style="list-style-type: none"> ■ 2 entries incorporating n° 13 cable gland or without cable gland, depending on model 	
G 1/4 or R 1/4 (female or male)			G 1/4, G 3/8 or 4 x G 1/4 (female), depending on model	
FTG●, FTG●NE	FSG●, FSG●NE	FYG22, FYG22NE	FYG32, FYG32NE	XMP
90 to 92				96 to 103

Electromechanical pressure and vacuum switches

OsiSense XM

Function

The function of pressure and vacuum switches is the control or regulation of pressure or vacuum levels in hydraulic or pneumatic systems. They transform the pressure change into a digital electrical signal when the preset switching points are reached.

Switches for power circuits

Switches with power electrical contacts, either 2-pole or 3-pole, designed for direct switching of single-phase or 3-phase motors (pumps, compressors, etc.).

Switches for control circuits

Switches with standard electrical contacts, designed for control of contactors, relays, power valves, PLC inputs, etc.

Pressure switch operating principle

Detection of a single threshold

The switches for detection of a single threshold (fixed differential) have a single adjustable setting point (PH). The differential between the high and low points (PH - PB) depends upon the natural characteristics of the switch. It is not adjustable.

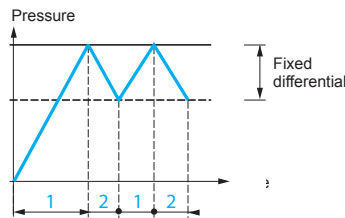

Example: contact schematics of XMLA

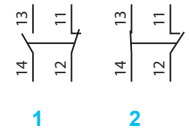

— Adjustable value
 --- Non adjustable value
 PH = High point
 PB = Low point

Regulation between 2 thresholds

The switches for regulation between 2 thresholds (adjustable differential) have both a high point setting (PH) and a low point setting (PB). Both of these points can be independently adjusted.

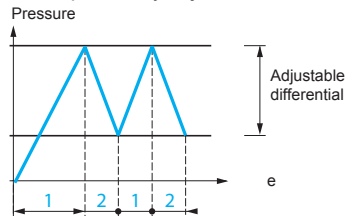

Example: contact schematics of XMLB

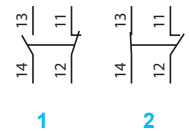

— Adjustable value
 --- Non adjustable value
 PH = High point
 PB = Low point

Detection of 2 thresholds

The dual stage switches, for detection at each threshold, have an adjustable high point setting for each stage (PH1 and PH2). Both of these points can be independently adjusted. For both stages, the differential between the high point and the low point (PH1 - PB1 and PH2 - PB2) depends upon the natural characteristics of the switch. It is not adjustable.

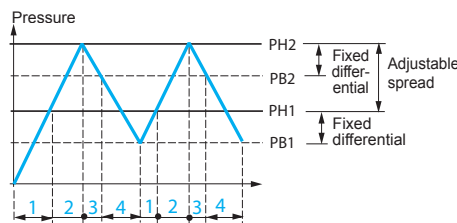

Example: contact schematics of XMLD

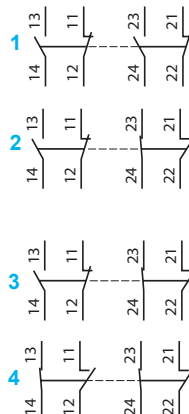

— Adjustable value
 --- Non adjustable value
 PH = High point
 PB = Low point

Electromechanical pressure and vacuum switches

OsiSense XM

Vacuum switch operating principle

Detection of a single threshold

The switches for detection of a single threshold (fixed differential) have a single adjustable setting point (PH). The differential between the high and low points (PH - PB) depends upon the natural characteristics of the switch. It is not adjustable.

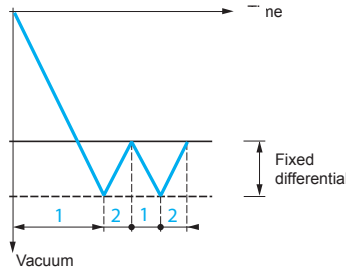

— Adjustable value
 --- Non adjustable value

PH = High point
 PB = Low point

Example: contact schematics of XMLA

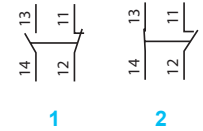

Regulation between 2 thresholds

The switches for regulation between 2 thresholds (adjustable differential) have both a high point setting (PH) and a low point setting (PB). Both of these points can be independently adjusted.

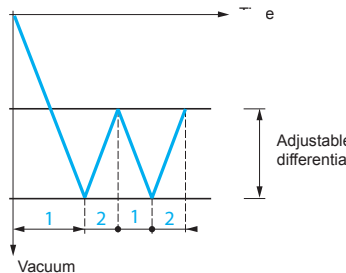

— Adjustable value

PH = High point
 PB = Low point

Example: contact schematics of XMLB

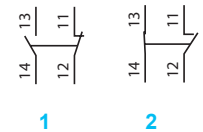

Detection of 2 thresholds

The dual stage switches, for detection at each threshold, have an adjustable high point setting for each stage (PH1 and PH2). Both of these points can be independently adjusted.

For both stages, the differential between the high point and the low point (PH1 - PB1 and PH2 - PB2) depends upon the natural characteristics of the switch. It is not adjustable.

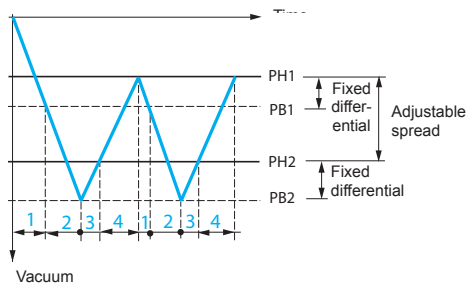

— Adjustable value
 --- Non adjustable value

PH = High point
 PB = Low point

Example: contact schematics of XMLD

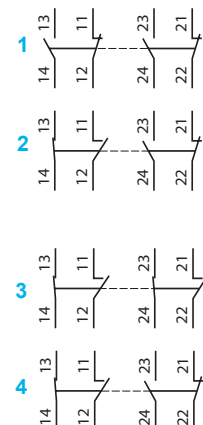

Electromechanical pressure and vacuum switches

OsiSense XM

Terminology

Operating range

The difference between the minimum low point (PB) and the maximum high point (PH) setting values.

Size

Pressure switches and vacuum-pressure switches (vacu-pressure switches)

Maximum value of the operating range.

Vacuum switches

Minimum value of the operating range.

Switching point on rising pressure (PH)

Pressure switches

The upper pressure setting at which the pressure switch will actuate the contacts on rising pressure.

Vacuum switches

The lower vacuum setting at which the vacuum switch will reset the contacts on rising pressure.

Switching point on falling pressure (PB)

The pressure at which the switch output changes state on falling pressure.

Switches with fixed differential

The lower point (PB) is not adjustable and is entirely dependent on the high point setting (PH) and the natural differential of the switch.

Switches with adjustable differential

The adjustable differential enables the independent setting of the lower point (PB).

Differential

The difference between the switching point on rising pressure (PH) and the switching point on falling pressure (PB).

Spread

For dual stage switches, the spread indicates the difference between the 2 switching points on rising pressure (PH2 and PH1) and, for vacuum switches, the difference between the 2 switching points on falling pressure (PB2 and PB1).

Accuracy (switches with setting scale)

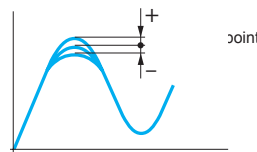

The tolerance between the point at which the switch actuates its contacts and the value indicated on the setting scale. Where very high setting accuracy is required (initial installation of the product), it is recommended to use separate measuring equipment (pressure gauge, etc.).

Electromechanical pressure and vacuum switches

OsiSense XM

Terminology (continued)

Repeat accuracy (R)

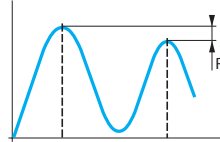

The tolerance between two consecutive switching operations.

Drift (F)

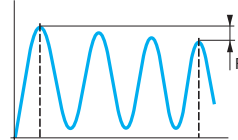

The tolerance of the switching point throughout the entire service life of the switch.

Accidental overpressure

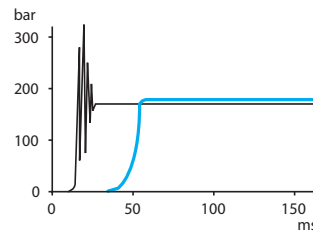

This is an accidental pressure surge of very short duration (a few milliseconds).

If accidental overpressures occur and their duration is less than 50 milliseconds, the pressure damping device incorporated in the XML switches (sizes 10 bar and greater) will diminish the effect.

Example 1: with destructive pressure level.

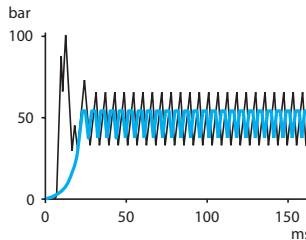

Example 2: with destructive pressure level and destructive pressure oscillations.

— Without damping device
 — With damping device

Maximum permissible pressure per cycle (Ps)

A pressure switch can withstand this pressure, without detrimental effect, on each cycle throughout its service life.

Its minimum value is at least equal to 1.25 times the switch size.

Maximum permissible accidental pressure

The maximum accidental pressure is at least equal to 2.25 times the switch size.

Destruction pressure

The maximum guaranteed pressure that the switch will withstand before its destruction, i.e. bursting, rupturing, component failure, etc.

Its value is at least equal to 4.5 times the switch size.

Electromechanical pressure and vacuum switches

OsiSense XM

Application range of pressure and vacuum switches XML, XMA and XMX, for control circuits

On standard loads
Continuous duty, frequent switching.

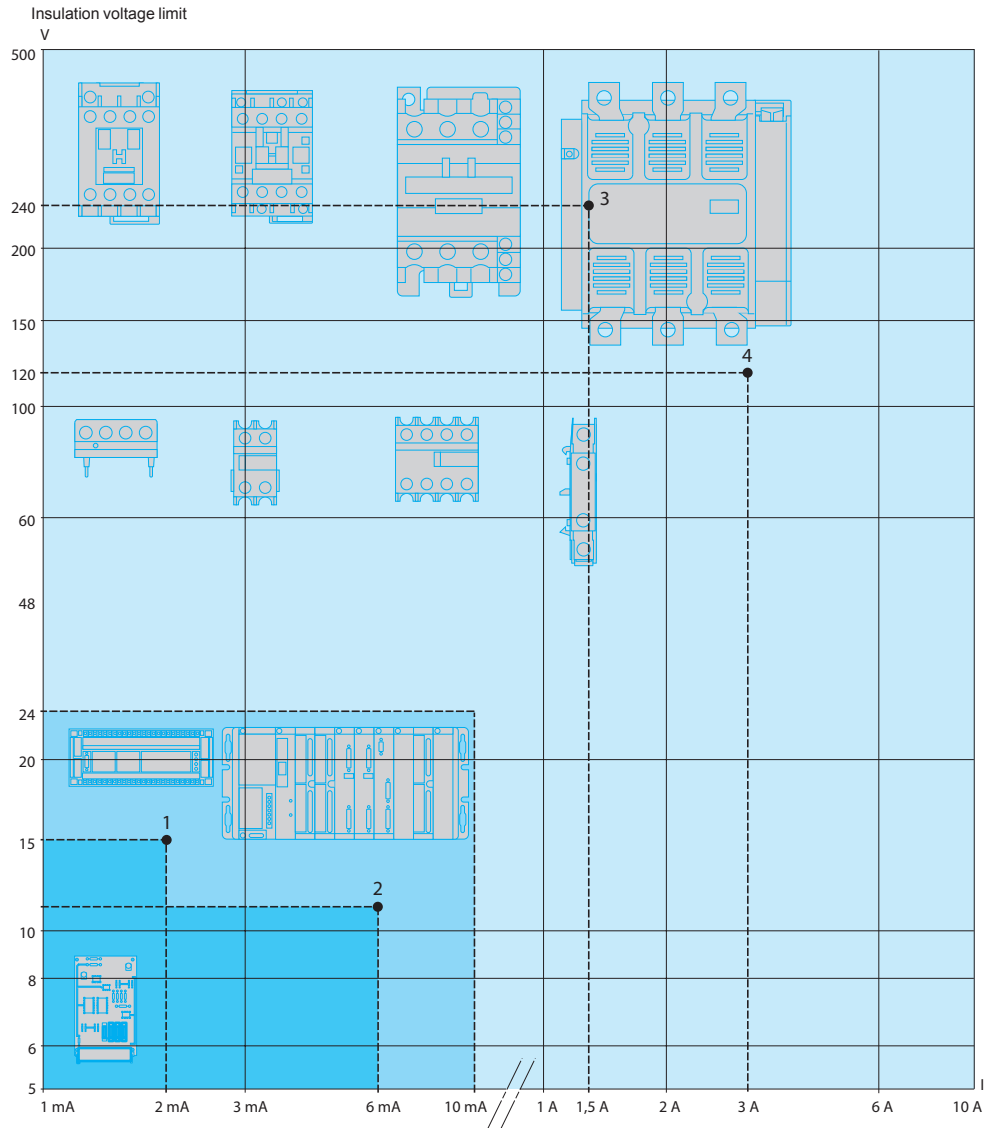

- 1 Standard PLC input, type 1
- 2 Standard PLC input, type 2
- 3 Switching capacity conforming to IEC 60947-5-1, utilisation category AC-15, DC-13
B300 240 V 1.5 A
R300 250 V 0.1 A
- 4 Switching capacity conforming to IEC 60947-5-1, utilisation category AC-15, DC-13
B300 120 V 3 A
R300 125 V 0.22 A

PLC: Programmable Logic Controller

On small loads

The use of electromechanical pressure and vacuum switches with programmable logic controllers is becoming more predominant. On small loads, the reliability of the switches maintain a failure rate of less than 1 for 100 million operating cycles.

Pressure switches	Application range	
XMLA XMLB XMLC XMLD XM, XMA		
XMLG XMLK		

Electromechanical pressure and vacuum switches

OsiSense XM

Selection of switch size

After establishing the type of switch required for the application (single threshold detection or regulation between 2 thresholds), the selection of its size will depend on the following criteria:

- the differential: difference between the high point (PH) and the low point (PB),
- the maximum pressure permissible per cycle,
- repeat accuracy, precision and minimum drift.

Examples of a fixed differential pressure switch selection, for detection of a single threshold

Main criterion: minimum differential

Example: for a selected high point (PH) of 7 bar

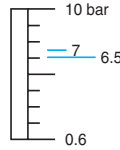

XMLA010●●●●●●
Differential = 0.5 bar

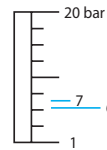

XMLA020●●●●●●
Differential = 1 bar

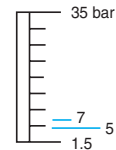

XMLA035●●●●●●
Differential = 2 bar

Select an XMLA010●●●●●● (the lowest size)

Main criterion: tolerance to overpressures

Example: for a selected high point (PH) of 12 bar

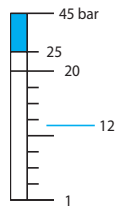

XMLA020●●●●●●
Permissible accidental overpressure = 45 bar

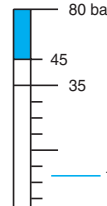

XMLA035●●●●●●
Permissible accidental overpressure = 80 bar

Select an XMLA035●●●●●● (the highest size)

Main criterion: repeat accuracy, precision and minimum drift

Example: for a selected high point (PH) of 18 bar

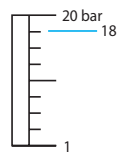

XMLA020●●●●●●

Adjustable from 1 to 20 bar

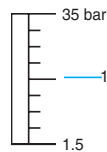

XMLA035●●●●●●

Adjustable from 1.5 to 35 bar

Select an XMLA035●●●●●●

As a general rule, working at the upper or lower limits of the operating range should be avoided.

Units of pressure conversion table

	psi	kg/cm ²	bar	atm	mm Hg (Torr)	mm H ₂ O	Pa
1 psi =	1	0.07031	0.06895	0.06805	51.71	703.7	6895
1 kg/cm ² =	14.22	1	0.98066	0.96784	735.55	10 000	98 066
1 bar =	14.50	1.0197	1	0.98695	750.06	10 197	10 ⁵
1 atm =	14.70	1.0333	1.0132	1	760.0	10 333	101 325
1 mm Hg = (Torr)	0.01934	1.360 x 10 ⁻³	1.333 x 10 ⁻³	1.316 x 10 ⁻³	1	13.59	133.3
1 mm H ₂ O =	1.421 x 10 ⁻³	10 ⁻⁴	~ 10 ⁻⁴	~ 10 ⁻⁴	0.07361	1	~ 9.80
1 Pa =	1.45 x 10 ⁻⁴	1.0197 x 10 ⁻⁵	10 ⁻⁵	9.8695 x 10 ⁻⁶	7.5 x 10 ⁻³	0.10197	1

Example: 1 bar = 14.50 psi = 10⁵ Pa

Electromechanical pressure and vacuum switches

Fixed differential switches, for detection of a single threshold

Adjustment range of the high point

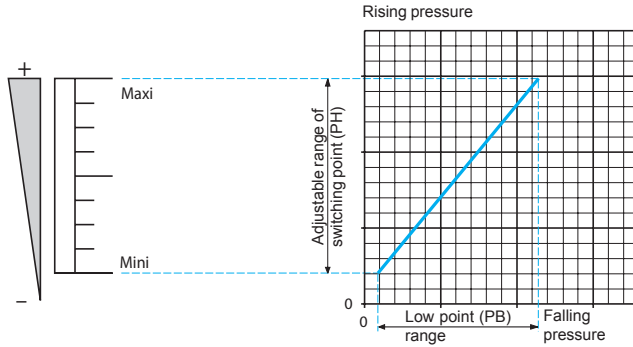

Defined by the difference between the minimum and maximum high point (PH) setting values.

For a high set point (PH), the lower point (PB) is fixed and cannot be adjusted.

For a low set point (PB1 or PB2), the higher point (PH1 or PH2) is fixed and cannot be adjusted.

Switching point on rising pressure (PH)

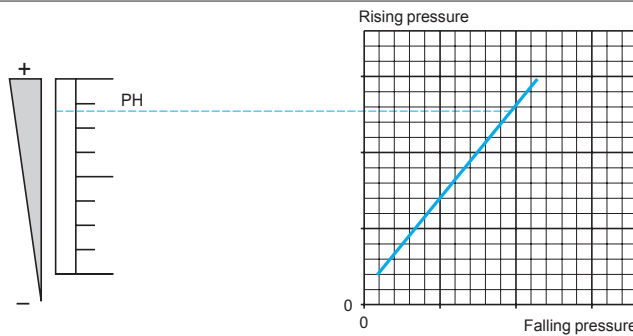

The upper pressure setting at which the pressure or vacuum switch will actuate the contacts on rising pressure.

Adjustable throughout the range on rising pressure.

Switching point on falling pressure (PB)

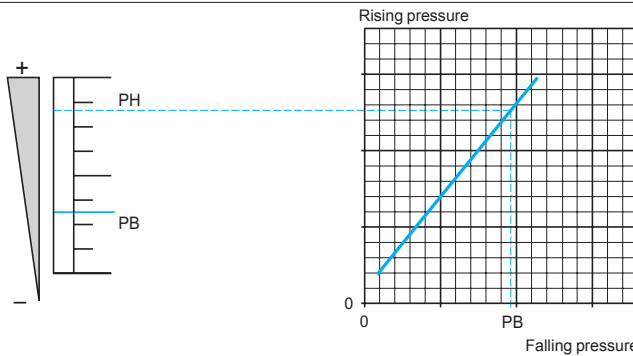

The pressure at which the switch contact changes state on falling pressure.

The lower point (PB) is not adjustable and is entirely dependent on the high point setting (PH) and the natural differential of the switch.

Differential

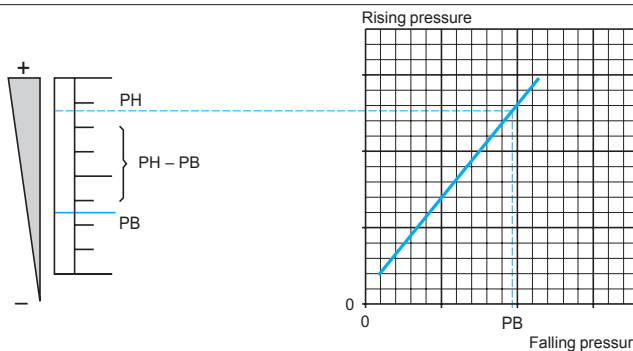

$PH - PB = \text{natural differential}$

The difference between the switching point on rising pressure (PH) and the switching point on falling pressure (PB).

This point is not adjustable and therefore, the value of the differential is fixed. It is the natural differential of the switch (contact differential, friction, etc.).

Example

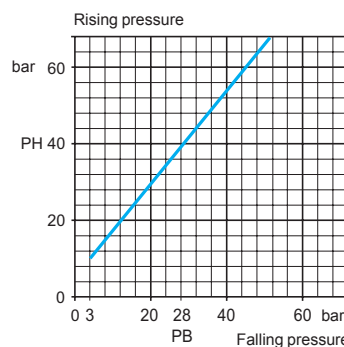

■ Consider a switching point on rising pressure (PH) of 40 bar (set value at which the contact will change state on rising pressure).

■ It can be seen that the switching point on falling pressure (PB) is 28 bar (fixed value at which the contact will return to its original state).

Conclusion:

□ the differential will be $40 - 28 = 12$ bar.

Electromechanical pressure and vacuum switches

Adjustable differential switches, for regulation between 2 thresholds

Adjustment range of the high point

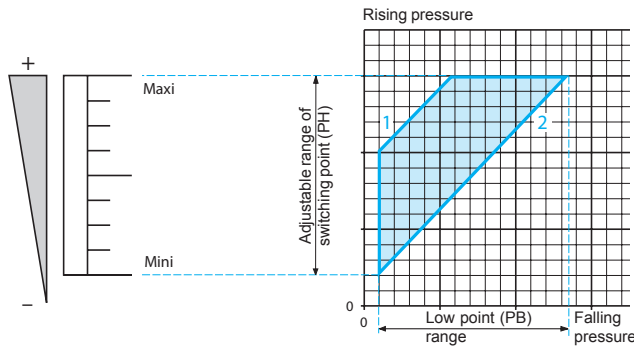

Defined by the difference between the minimum and maximum high point (PH) setting values.

Switching point on rising pressure (PH)

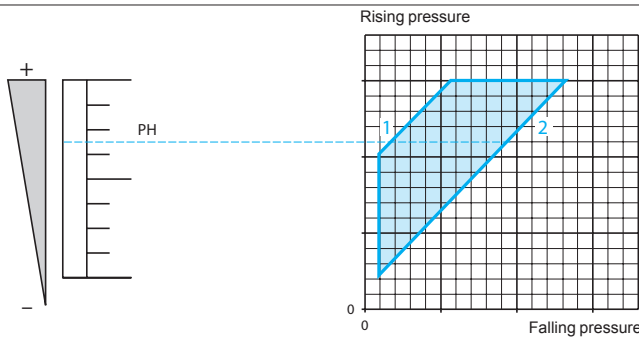

The upper pressure setting at which the pressure or vacuum switch will actuate the contacts on rising pressure.

Adjustable throughout the range on rising pressure.

Switching point on falling pressure (PB)

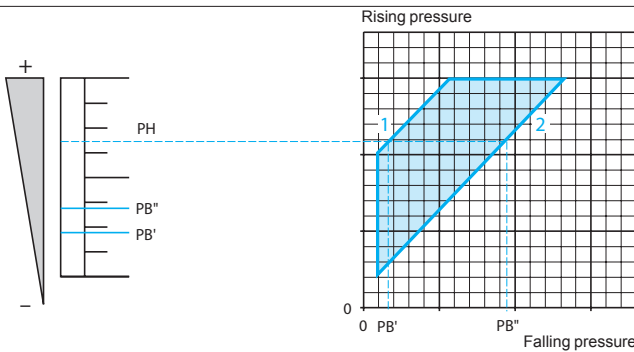

The pressure at which the switch contact changes state on falling pressure.

The adjustable differential enables the independent setting of the lower point (PB).

Differential

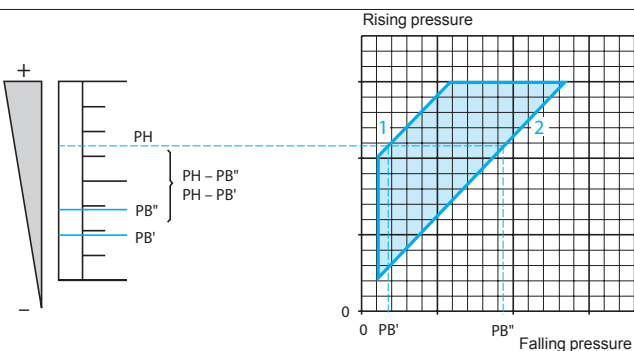

Low point < High point
 $PH - PB'' = \text{natural differential}$
 $PH - PB' = \text{minimum differential}$

The difference between the switching point on rising pressure (PH) and the switching point on falling pressure (PB).

Note: the low point can be set at any value between PB' and PB'' .

Example

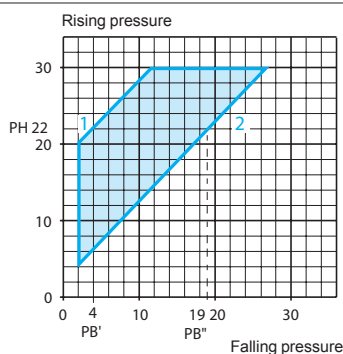

- 1 Maximum differential
- 2 Minimum differential

■ Consider a switching point on rising pressure (PH) of 22 bar (set value at which the contact will change state on rising pressure).

■ It can be seen that the switching point on falling pressure (PB) can be between 4 and 19 bar inclusive (set value at which the contact will return to its original state).

Conclusion:

- the maximum differential will be: $22 - 4 = 18$ bar,
- the minimum differential will be: $22 - 19 = 3$ bar.

Operating curves (switching points on rising pressure)

Electromechanical pressure and vacuum switches

Dual stage, fixed differential switches, for detection at each threshold

Adjustment ranges of the switching points PH1 and PH2 on rising pressure

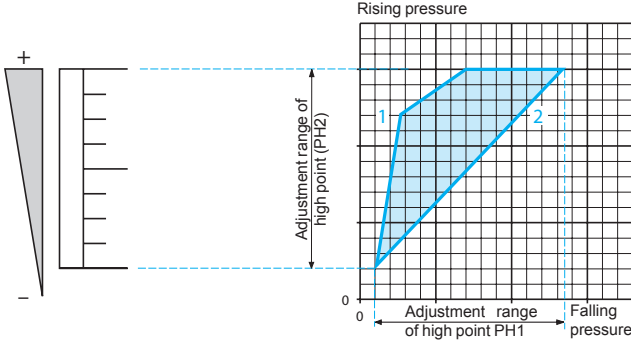

Defined by the difference between the minimum and maximum high point setting values of each stage (PH1 and PH2).

Switching point PH2 on rising pressure

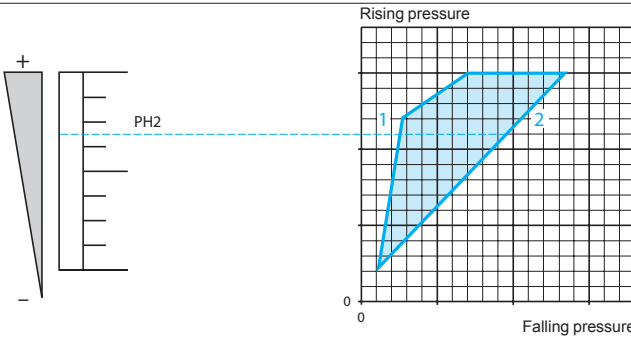

The upper pressure setting at which the pressure or vacuum switch will actuate the contacts on rising pressure.

Adjustable throughout the range on rising pressure.

Switching point PH1 on rising pressure

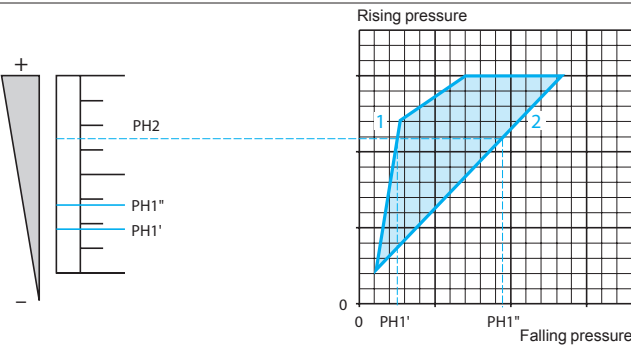

The upper pressure setting at which the pressure or vacuum switch will actuate contact 1 on rising pressure.

Spread

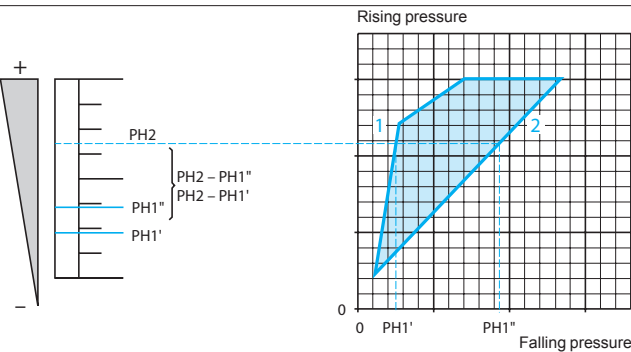

$PH1 < PH2$
 $PH2 - PH1'' = \text{maximum spread}$
 $PH2 - PH1' = \text{minimum spread}$

The difference between switching points PH2 and PH1 on rising pressure.

Note: switching point PH1 can be set at any value between PH1' and PH1''.

Example:
Determining switching points on rising pressure for the 2 stages

- 1 Maximum spread
- 2 Minimum spread

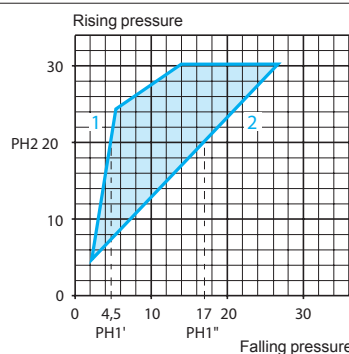

■ Consider a 2nd stage switching point on rising pressure (PH2) of 20 bar (set value at which contact 2 will change state on rising pressure).

■ It can be seen that the 1st stage switching point (PH1) can be set between 4.5 and 17 bar on rising pressure.

Conclusion:

- the maximum spread will be: $20 - 4.5 = 15.5 \text{ bar}$,
- the minimum spread will be: $20 - 17 = 3 \text{ bar}$.

Operating curves (switching points on falling pressure)

Electromechanical pressure and vacuum switches

Dual stage, fixed differential switches, for detection at each threshold

Adjustment range of high point (PH1 or PH2)

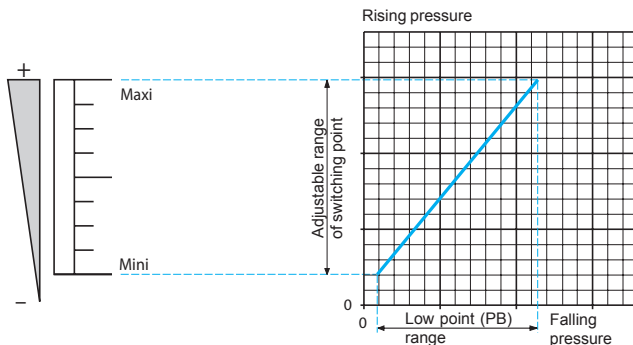

Defined by the difference between the minimum and maximum high point (PH1 or PH2) setting values for each stage.

For a high set point (PH), the lower point (PB) is fixed and cannot be adjusted.

For a low set point (PB1 or PB2), the higher point (PH1 or PH2) is fixed and cannot be adjusted.

Switching point on rising pressure (PH1 or PH2)

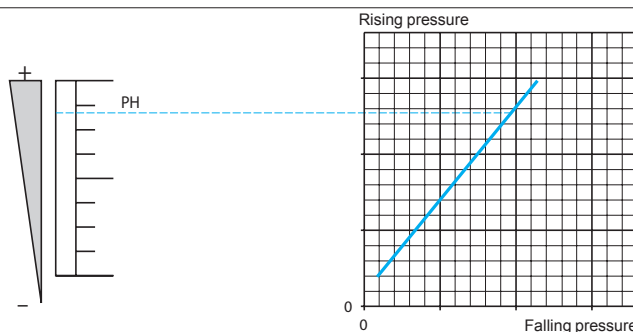

The upper pressure setting at which the pressure or vacuum switch will actuate the contact, for each stage, on rising pressure.

Adjustable throughout the range on rising pressure.

Switching point on falling pressure (PB1 or PB2)

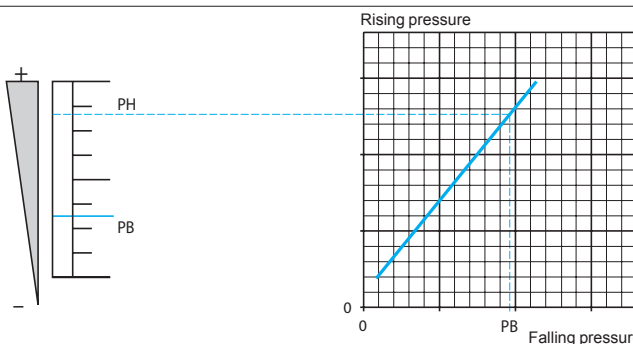

The pressure at which the switch contact changes state, for each stage, on falling pressure.

The lower point (PB) is not adjustable and is entirely dependent on the high point setting (PH) and the natural differential of the switch.

Differential

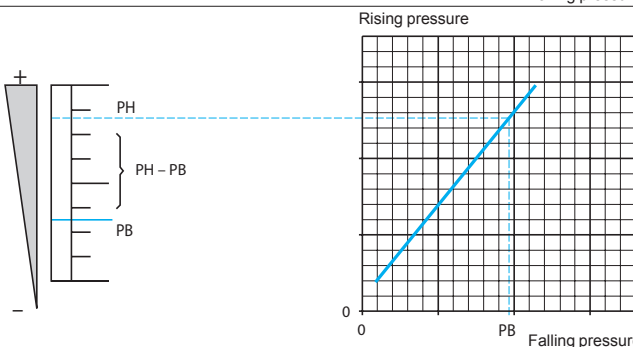

$PH - PB = \text{natural differential}$
The difference between the switching point on rising pressure (PH) and the switching point on falling pressure (PB), for each stage.

This point is not adjustable and therefore, the value of the differential is fixed. It is the natural differential of the switch (contact differential, friction, etc.), for each of its 2 stages.

Example:
stage 1 = segment EF
stage 2 = segment GH

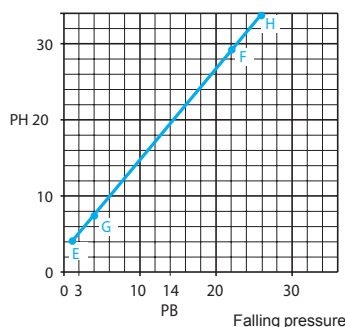

- 1 Maximum spread
- 2 Minimum spread

For stage 2 (segment GH):

- Consider a switching point on rising pressure (PH2) of 20 bar (set value at which contact 2 will change state on rising pressure).

- It can be seen that the switching point on falling pressure (PB2) is 14 bar (fixed value at which contact 2 will return to its original state).

Conclusion:

for stage 2, the differential will be:
 $20 - 14 = 6 \text{ bar}$.

Repeat the same procedure for stage 1 (segment EF).

Electromechanical pressure and vacuum switches

OsiSense XM

OsiSense XML for control circuits

Presentation

OsiSense **XML** pressure and vacuum switches are designed for use in control circuits.

They are used to control the pressure of hydraulic oils, fresh water, sea water, air, steam, corrosive fluids or viscous products, up to 500 bar.

OsiSense **XMLA** pressure and vacuum switches have a fixed differential and are used for detection of a single threshold. They incorporate 1 CO single-pole contact. OsiSense **XMLB** pressure and vacuum switches have an adjustable differential and are used for regulation between 2 thresholds. They incorporate 1 CO single-pole contact.

OsiSense **XMLC** pressure and vacuum switches have an adjustable differential and are used for regulation between 2 thresholds. They incorporate 2 CO single-pole contacts.

OsiSense **XMLD** pressure and vacuum switches are dual stage switches, each stage with a fixed differential, and are used for detection at each threshold. They incorporate 2 CO single-pole contacts (one per stage).

Setting

When setting OsiSense XML pressure and vacuum switches, adjust the switching point on rising pressure (PH) first and then the switching point on falling pressure (PB).

OsiSense XMLA pressure and vacuum switches with fixed differential

Switching point on rising pressure

The switching point on rising pressure (PH) is set by adjusting the red screw **1**.

Switching point on falling pressure

The switching point on falling pressure (PB) is not adjustable.

The difference between the tripping and resetting points of the contact is the natural differential of the switch (contact differential, friction, etc.).

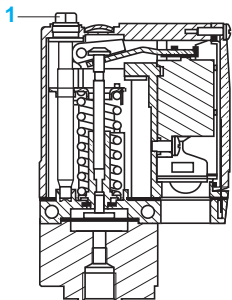

OsiSense XMLB and XMLC pressure and vacuum switches with adjustable differential

Switching point on rising pressure

The switching point on rising pressure (PH) is set by adjusting the red screw **1**.

Switching point on falling pressure

The switching point on falling pressure (PB) is set by adjusting the green screw **2**.

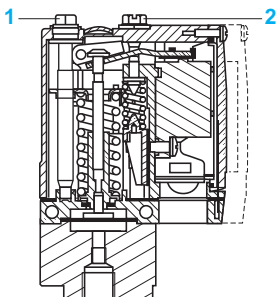

OsiSense XMLD dual stage pressure and vacuum switches with fixed differential for each threshold

Switching point on rising pressure of stage 1 and stage 2

The first stage switching point on rising pressure (PH1) is set by adjusting the red screw **1**.

The second stage switching point on rising pressure (PH2) is set by adjusting the blue screw **2**.

Switching point on falling pressure

The switching points on falling pressure (PB1 and PB2) are not adjustable.

The difference between the tripping and resetting points of each contact is the natural differential of the switch (contact differential, friction, etc.).

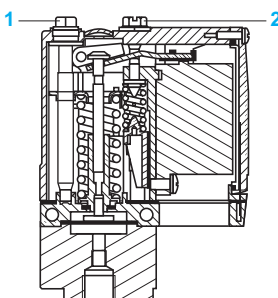

Electromechanical pressure and vacuum switches

OsiSense XM

OsiSense XML for control circuits

Environment characteristics	
Conformity to standards	CE, IEC/EN 60947-5-1, UL 508, CSA C22-2 no. 14
Product certifications	All products: UL, CSA, EAC XMLA and XMLB: CCC, BV, LROS
Protective treatment	Standard version "TC". Special version "TH"
Ambient air temperature	°C For operation: -25...+70. For storage: -40...+70
Fluids or products controlled	Hydraulic oils, air, fresh water, sea water Steam, corrosive fluids, viscous products, depending on model
Materials	Case: zinc alloy Component materials in contact with fluid: see pages 72 and 73
Operating position	All positions
Vibration resistance	4 gn (30...500 Hz) conforming to IEC 60068-2-6 except XML●L35●●●●●, XML●001●●●●● and XMLBM03●●●●●: 2 gn
Shock resistance	50 gn conforming to IEC 60068-2-27 except XML●L35●●●●●, XML●001●●●●● and XMLBM03●●●●●: 30 gn
Electric shock protection	Class I conforming to IEC 1140, IEC 536 and NF C 20-030
Degree of protection	Screw terminal models: IP 66 conforming to IEC/EN 60529 Connector models: IP 65 conforming to IEC/EN 60529
Operating rate	Op. cycles/min Piston version switches: ≤ 60 (for temperatures > 0 °C) Diaphragm version switches: ≤ 120 (for temperatures > 0 °C)
Repeat accuracy	< 2%
Fluid connection	G 1/4 (BSP female) conforming to NF E 03-005, ISO 228 or 1/4"-18 NPTF For sizes ≥ 300 bar, use the gasket supplied with the product. This gasket is also available as a separate part, reference XMLZL010.
Electrical connection	Screw terminal models: ISO M20 x 1.5 or 1/2" NPT tapped entry For an entry tapped for no.13 (DIN Pg 13.5) cable gland, replace the last number of the reference with 1 (for example, XMLA010A2S12 becomes XMLA010A2S11) Connector models: EN 175301-803-A (ex-DIN 43650) connector

Contact block characteristics	
Rated operational characteristics	~ AC-15, B300 (Ue = 240 V, Ie = 1.5 A; Ue = 120 V, Ie = 3 A) --- DC-13; R300 (Ue = 250 V, Ie = 0.1 A), conforming to IEC 60947-5-1 Appendix A, EN 60947-5-1
Rated insulation voltage	Ui = 500 V conforming to IEC/EN 60947-1 Ui = 300 V conforming to UL 508, CSA C22-2 no. 14
Rated impulse withstand voltage	U imp = 6 kV conforming to IEC/EN 60947-1
Type of contacts	Silver tipped contacts XMLA and XMLB: 1 CO single-pole contact (4 terminals), snap action XMLC: 2 CO single-pole contacts (8 terminals), simultaneous, snap action XMLD: 2 CO single-pole contacts (8 terminals), staggered, snap action
Resistance across terminals	mΩ < 25 conforming to NF C 93-050 method A or IEC 255-7 category 3
Terminal referencing	Conforming to CENELEC EN 50013
Short-circuit protection	10 A cartridge fuse type gG (gl)
Connection	Screw clamp terminals. Minimum clamping capacity: 1 x 0.5 mm ² /AWG 20 Maximum clamping capacity: 2 x 2.5 mm ² /AWG 14

Electrical durability
Conforming to IEC/EN 60947-5-1 Appendix C
Utilisation categories AC-15 and DC-13

Operating rate: 3600 operating cycles/hour
Load factor: 0.5

XMLA and XMLB
AC supply ~ 50/60 Hz
~ Inductive circuit, Ithe = 10 A

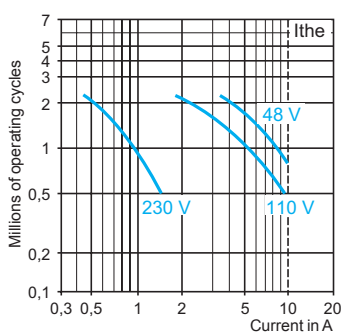

DC supply ---
Power broken in W for 1 million operating cycles

Voltage V	24	48	120
~ W	31	29	26

XMLC and XMLD
AC supply ~ 50/60 Hz
~ Inductive circuit, Ithe = 10 A

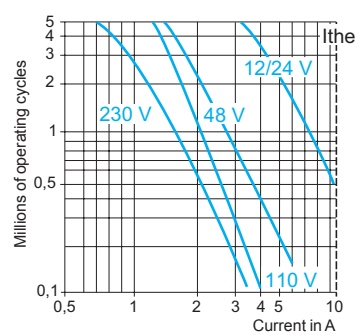

DC supply ---
Power broken in W for 5 million operating cycles

Voltage V	24	48	120
~ W	10	7	4

Electromechanical vacuum switches

OsiSense XML

Size - 1 bar (- 14.5 psi)
Fixed differential, for detection of a single threshold
Switches with 1 CO single-pole contact

OsiSense XMLA vacuum switches **With setting scale**

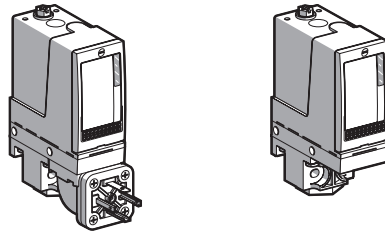

Adjustable range of switching point (PB) (Falling pressure)	- 0.28...- 1 bar (- 4.06...- 14.5 psi)		
Electrical connection	DIN connector	Terminals	
Fluid connection	G 1/4 (female)	G 1/4 (female)	1/4"-18 NPTF (female)

References (1)

Fluids controlled (2)	Hydraulic oils, fresh water, air, up to + 70 °C	XMLAM01V2C11	XMLAM01V2S12	XMLAM01V2S13
	Hydraulic oils, fresh water, air, corrosive fluids, up to + 160 °C Sea water, up to + 30 °C	XMLAM01T2C11	XMLAM01T2S12	—
Weight (kg)		0.685	0.715	0.715

Complementary characteristics not shown under general characteristics (page 17)

Natural differential (add to PB to give PH)	At low setting (3)	0.24 bar (3.48 psi)		
	At high setting (3)	0.24 bar (3.48 psi)		
Maximum permissible pressure	Per cycle	5 bar (72.5 psi)		
	Accidental	9 bar (130.5 psi)		
Destruction pressure		18 bar (261 psi)		
Mechanical life		3 x 10 ⁶ operating cycles		
Connection		EN 175301-803-A (ex-DIN 43650A), 4-pin male connector. For suitable female connector, see page 68	1 entry tapped M20 x 1.5 mm for ISO cable gland, clamping capacity 7 to 13 mm	1 entry tapped 1/2"-14 NPT for cable gland, clamping capacity 7 to 13 mm
Vacuum switch type		Diaphragm		

- (1) For 1 entry tapped for no. 13 cable gland, replace **S12** with **S11** (for example, **XMLAM01V2S12** becomes **XMLAM01V2S11**).
- (2) For component materials of units in contact with the fluid, see pages 72 and 73.
- (3) Deviation of the differential at low and high setting points for switches of the same size: ± 0.05 bar (± 0.72 psi).

Operating curves **Connection**

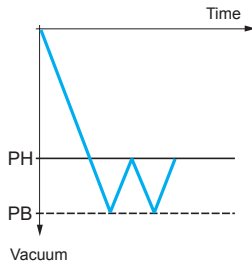
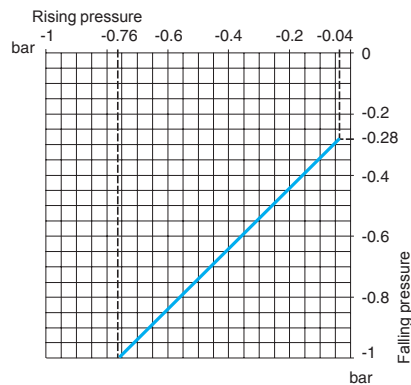

Terminal model



Connector model

Vacuum switch connector pin view

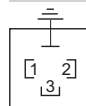

- 1 → 11 and 13
- 2 → 12
- 3 → 14

- Adjustable value
- Non adjustable value

Other versions For vacuum switches with alternative tapped cable entries, such as NPT, etc. please consult our Customer Care Centre.

Electromechanical vacuum switches

OsiSense XM, OsiSense XML

Size - 1 bar (- 14.5 psi)
Adjustable differential, for regulation between 2 thresholds
Switches with 1 CO single-pole contact

OsiSense XMLB vacuum switches

With setting scale

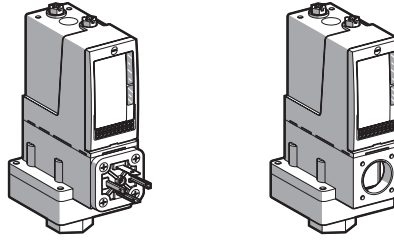

Adjustable range of switching point (PB) (Falling pressure)	- 0.14...- 1 bar (- 2.03...- 14.5 psi)		
Electrical connection	DIN connector	Terminals	
Fluid connection	G 1/4 (female)	G 1/4 (female)	1/4"-18 NPTF (female)

References (1)

Fluids controlled (2)	Hydraulic oils, fresh water, air, up to + 70 °C	XMLBM02V2C11	XMLBM02V2S12	XMLBM02V2S13
	Hydraulic oils, fresh water, air, corrosive fluids, up to + 160 °C Sea water, up to + 30 °C	XMLBM02T2C11	XMLBM02T2S12	XMLBM02T2S13
Weight (kg)		1.015	1.030	1.030

Complementary characteristics not shown under general characteristics (page 17)

Possible differential (add to PB to give PH)	Min. at low setting (3)	0.13 bar (1.88 psi)	
	Min. at high setting (3)	0.13 bar (1.88 psi)	
	Max. at high setting	0.8 bar (11.6 psi)	
Maximum permissible pressure	Per cycle	5 bar (72.5 psi)	
	Accidental	9 bar (130.5 psi)	
Destruction pressure		18 bar (261 psi)	
Mechanical life		3 x 10 ⁸ operating cycles	
Connection	EN 175301-803-A (ex-DIN 43650A), 4-pin male connector. For suitable female connector, see page 68	1 entry tapped M20 x 1.5 mm for ISO cable gland, clamping capacity 7 to 13 mm	1 entry tapped 1/2"-14 NPT for cable gland, clamping capacity 7 to 13 mm
	Vacuum switch type	Diaphragm	

(1) For 1 entry tapped for no. 13 cable gland, replace **S12** with **S11** (for example, **XMLBM02V2S12** becomes **XMLBM02V2S11**).

(2) For component materials of units in contact with the fluid, see pages 72 and 73.

(3) Deviation of the differential at low and high setting points for switches of the same size: ± 0.02 bar (± 0.29 psi).

Operating curves

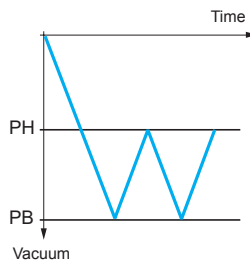
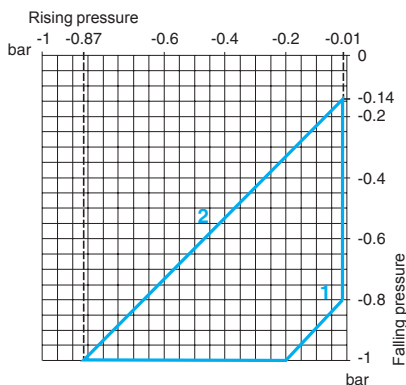

Connection

Terminal model



Connector model

Vacuum switch connector pin view

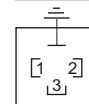

1 → 11 and 13
2 → 12
3 → 14

- 1 Maximum differential
- 2 Minimum differential

— Adjustable value

Other versions

For vacuum switches with alternative tapped cable entries, such as NPT, etc. please consult our Customer Care Centre.

Electromechanical vacuum switches

OsiSense XML

Size - 1 bar (- 14.5 psi)
Adjustable differential, for regulation between 2 thresholds
Switches with 2 CO single-pole contacts

OsiSense XMLC vacuum switches

With setting scale

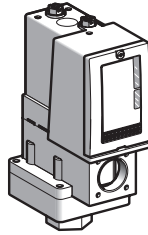

Adjustable range of switching point (PB) (Falling pressure)	- 0.14...- 1 bar (- 2.03...- 14.5 psi)
Electrical connection	Terminals
Fluid connection	G 1/4 (female)

References (1)

Fluids controlled (2)	Hydraulic oils, fresh water, air, up to + 70 °C	XMLCM02V2S12
	Hydraulic oils, fresh water, air, corrosive fluids, up to + 160 °C Sea water, up to + 30 °C	XMLCM02T2S12

Weight (kg)	1.015
-------------	-------

Complementary characteristics not shown under general characteristics (page 17)

Possible differential (add to PB to give PH)	Min. at low setting (3)	0.13 bar (1.89 psi)
	Min. at high setting (3)	0.14 bar (2.03 psi)
	Max. at high setting	0.8 bar (11.6 psi)
Maximum permissible pressure	Per cycle	5 bar (72.5 psi)
	Accidental	9 bar (130.5 psi)
Destruction pressure		18 bar (261 psi)
Mechanical life		3 x 10 ⁶ operating cycles
Cable entry for terminal models		1 entry tapped M20 x 1.5 mm for ISO cable gland, clamping capacity 7 to 13 mm
Vacuum switch type		Diaphragm

- (1) For 1 entry tapped for no. 13 cable gland, replace **S12** with **S11** (for example, **XMLCM02V2S12** becomes **XMLCM02V2S11**).
- (2) For component materials of units in contact with the fluid, see pages 72 and 73.
- (3) Deviation of the differential at low and high setting points for switches of the same size: ± 0.02 bar (± 0.29 psi).

Operating curves

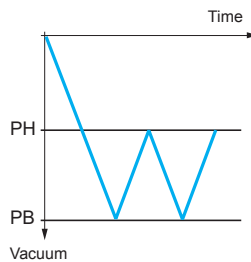
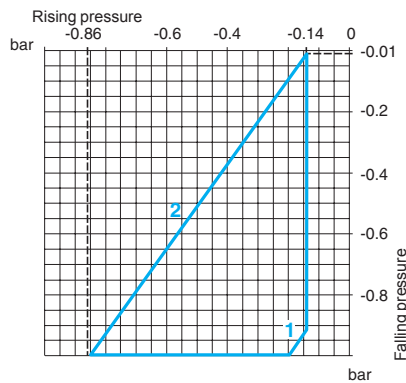

Connection

Terminal model

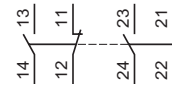

- 1 Maximum differential
- 2 Minimum differential

— Adjustable value

Other versions

For vacuum switches with alternative tapped cable entries, such as NPT, etc. please consult our Customer Care Centre.

OsiSense XML

Size - 1 bar (- 14.5 psi)

Dual stage, fixed differential, for detection at each threshold

Switches with 2 CO single-pole contacts

OsiSense XMLD vacuum switches

Without setting scale

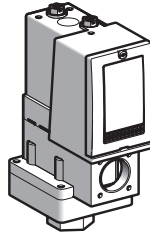

Adjustable range of each switching point (Falling pressure)	2nd stage switching point (PB2) 1st stage switching point (PB1)	- 0.12...- 1 bar (- 1.74...- 14.5 psi) - 0.10...- 0.98 bar (- 1.45...- 14.21 psi)
Spread between 2 stages (PB2 - PB1)		0.02...0.88 bar (0.29...12.76 psi)
Electrical connection		Terminals
Fluid connection		G 1/4 (female)

References (1)

Fluids controlled (2)	Hydraulic oils, fresh water, air, up to + 70 °C	XMLDM02V1S12
	Hydraulic oils, fresh water, air, corrosive fluids, up to + 160 °C Sea water, up to + 30 °C	XMLDM02T1S12
Weight (kg)		1.015

Complementary characteristics not shown under general characteristics (page 17)

Natural differential (add to PB1/PB2 to give PH1/PH2)	At low setting (3)	0.1 bar (1.45 psi)
	At high setting (4)	0.1 bar (1.45 psi)
Maximum permissible pressure	Per cycle	5 bar (72.5 psi)
	Accidental	9 bar (130.5 psi)
Destruction pressure		18 bar (261 psi)
Mechanical life		3 x 10 ⁶ operating cycles
Cable entry for terminal models		1 entry tapped M20 x 1.5 mm for ISO cable gland, clamping capacity 7 to 13 mm
Vacuum switch type		Diaphragm

(1) For 1 entry tapped for no. 13 cable gland, replace S12 with S11 (for example, XMLDM02V1S12 becomes XMLDM02V1S11).

(2) For component materials of units in contact with the fluid, see pages 72 and 73.

(3) Deviation of the differential at low setting point for switches of the same size:
± 0.035 bar (± 0.51 psi)

(4) Deviation of the differential at high setting point for switches of the same size:
± 0.02 bar (± 0.29 psi).

Operating curves

High setting tripping points of contacts 1 and 2

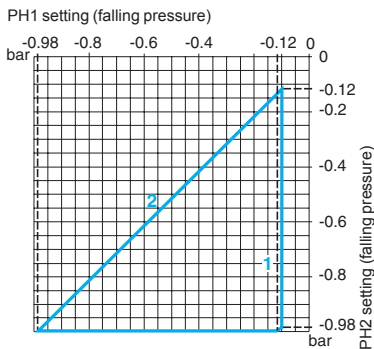

- 1 Maximum differential
- 2 Minimum differential

Natural differential of contacts 1 and 2

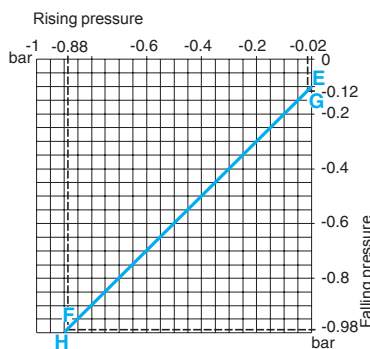

- EF Contact 1 (stage 1)
- GH Contact 2 (stage 2)

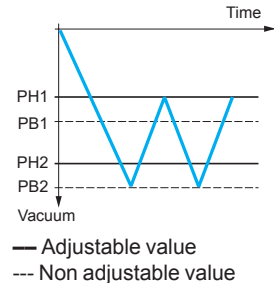

Connection

Terminal model

Contact 1 (stage 1)
Contact 2 (stage 2)

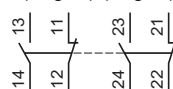

Other versions

For vacuum switches with alternative tapped cable entries, such as NPT, etc. please consult our Customer Care Centre.

Electromechanical vacuum switches

OsiSense XML

Size - 200 mbar (- 2.9 psi)

Adjustable differential, for regulation between 2 thresholds

Switches with 1 CO single-pole contact

OsiSense XMLB vacuum switches

With setting scale

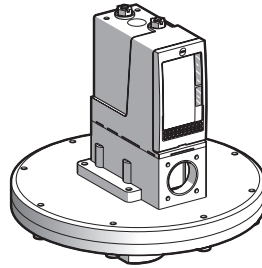

Adjustable range of switching point (PB) (Falling pressure)	- 20...- 200 mbar (- 0.29...- 2.9 psi)	
Electrical connection	Terminals	
Fluid connection	G 1/4 (female)	1/4"-18 NPTF (female)

References (1)

Fluids controlled (2)	Hydraulic oils, air, up to + 160 °C	XMLBM03R2S12	XMLBM03R2S13
Weight (kg)		3.310	3.310

Complementary characteristics not shown under general characteristics (page 17)

Possible differential (add to PB to give PH)	Min. at low setting (3)	18 mbar (0.26 psi)
	Min. at high setting (3)	18 mbar (0.26 psi)
	Max. at high setting	180 mbar (2.6 psi)
Maximum permissible pressure	Per cycle	1 bar (14.5 psi)
	Accidental	2 bar (29 psi)
Destruction pressure	3.5 bar (50.75 psi)	
Mechanical life	3 x 10 ⁸ operating cycles	
Cable entry for terminal models	1 entry tapped M20 x 1.5 mm for ISO cable gland, clamping capacity 7 to 13 mm	1 entry tapped 1/2"-14 NPT for cable gland, clamping capacity 7 to 13 mm
Vacuum switch type	Diaphragm	

(1) For 1 entry tapped for no. 13 cable gland, replace **S12** with **S11** (for example, **XMLBM03R2S12** becomes **XMLBM03R2S11**).

(2) For component materials of units in contact with the fluid, see pages 72 and 73.

(3) Deviation of the differential at low and high setting points for switches of the same size: ± 2 mbar (± 0.29 psi).

Operating curves

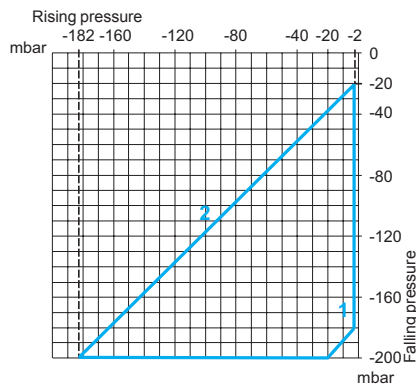

Connection

Terminal model



- 1 Maximum differential
- 2 Minimum differential

— Adjustable value

Other versions

For vacuum switches with alternative tapped cable entries, such as NPT, etc. please consult our Customer Care Centre.

OsiSense XMLB pressure switches

With setting scale

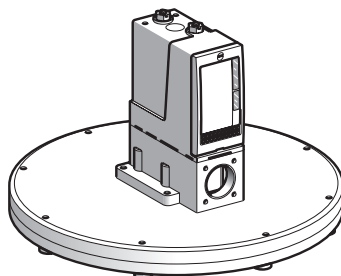

Adjustable range of switching point (PH) (Rising pressure)	2.6...50 mbar (0.038...0,72 psi)
Electrical connection	Terminals
Fluid connection	G 1/4 (female)

References (1)

Fluids controlled (2)	Hydraulic oils, air, up to + 160 °C	XMLBL05R2S12
	Fresh water, corrosive fluids, up to + 160 °C	XMLBL05S2S12
Weight (kg)		2.420

Complementary characteristics not shown under general characteristics (page 17)

Possible differential (subtract from PH to give PB)	Min. at low setting (3)	1.4 mbar (0.02 psi)
	Min. at high setting (4)	4 mbar (0.06 psi)
	Max. at high setting	40 mbar (0.58 psi)
Maximum permissible pressure	Per cycle	62.5 mbar (0.90 psi)
	Accidental	112.5 mbar (1.63 psi)
Destruction pressure		225 mbar (3.26 psi)
Mechanical life		6 x 10 ⁸ operating cycles
Cable entry for terminal models		1 entry tapped M20 x 1.5 mm for ISO cable gland, clamping capacity 7 to 13 mm
Pressure switch type		Diaphragm

(1) For 1 entry tapped for no. 13 cable gland, replace S12 with S11 (for example, XMLBL05R2S12 becomes XMLBL05R2S11).

(2) For component materials of units in contact with the fluid, see pages 72 and 73.

(3) Deviation of the differential at low setting point for switches of the same size:
- 0.8 mbar, + 1.1 mbar (- 0.01 psi, + 0.02 psi).

(4) Deviation of the differential at high setting point for switches of the same size:
± 1.4 mbar, (+ 0.02 psi).

Operating curves

Connection

Terminal model

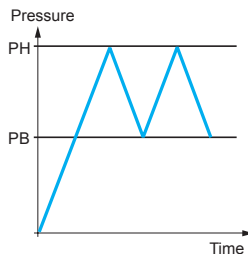
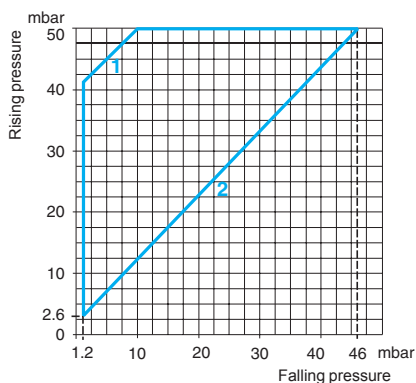

- 1 Maximum differential
- 2 Minimum differential

— Adjustable value

Other versions

For pressure switches with EN 175301-803-A (ex-DIN 43650A) connector or with alternative tapped cable entries, such as NPT, etc. please consult our Customer Care Centre.

Electromechanical vacu-pressure switches

OsiSense XML. Size 5 bar (72.5 psi)
Adjustable differential, for regulation between 2 thresholds
Switches with 1 CO single-pole contact

OsiSense XMLB vacu-pressure switches

With setting scale

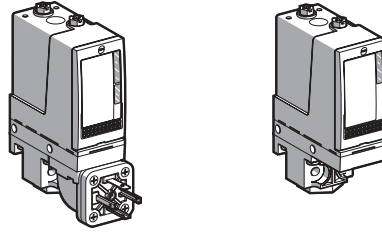

Adjustable range of switching point (PH) (Rising pressure)	- 0.5...5 bar (- 7.25...72.5 psi)		
Electrical connection	DIN connector	Terminals	
Fluid connection	G 1/4 (female)	G 1/4 (female)	1/4"-18 NPTF (female)

References (1)

Fluids controlled (2)	Hydraulic oils, fresh water, air, up to + 70 °C	XMLBM05A2C11	XMLBM05A2S12	XMLBM05A2S13
	Hydraulic oils, fresh water, air, up to + 160 °C	XMLBM05B2C11	XMLBM05B2S12	—
	Corrosive fluids, up to + 160 °C	XMLBM05C2C11	XMLBM05C2S12	—
	Viscous products, up to + 160 °C (G 1/4" fluid connection)	XMLBM05P2C11	XMLBM05P2S12	—
Weight (kg)		0.715	0.685	0.685

Complementary characteristics not shown under general characteristics (page 17)

Possible differential (subtract from PH to give PB)	Min. at low setting (3)	0.5 bar (7.25 psi)		
	Min. at high setting (3)	0.5 bar (7.25 psi)		
	Max. at high setting	6 bar (87 psi)		
Maximum permissible pressure	Per cycle	6.25 bar (90.62 psi)		
	Accidental	11.25 bar (163.12 psi)		
Destruction pressure		23 bar (333.5 psi)		
Mechanical life		3 x 10 ⁶ operating cycles		
Connection		EN 175301-803-A (ex-DIN 43650A), 4-pin male connector. For suitable female connector, see page 68	1 entry tapped M20 x 1.5 mm for ISO cable gland, clamping capacity 7 to 13 mm	1 entry tapped 1/2"-14 NPT for cable gland, clamping capacity 7 to 13 mm
Vacu-pressure switch type		Diaphragm		

(1) For 1 entry tapped for no. 13 cable gland, replace **S12** with **S11** (for example, **XMLBM05A2S12** becomes **XMLBM05A2S11**).

(2) For component materials of units in contact with the fluid, see pages 72 and 73.

(3) Deviation of the differential at low and high setting points for switches of the same size: ± 0.05 bar (± 0.72 psi).

Operating curves

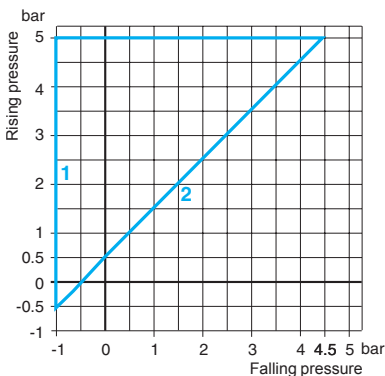

- 1 Maximum differential
- 2 Minimum differential

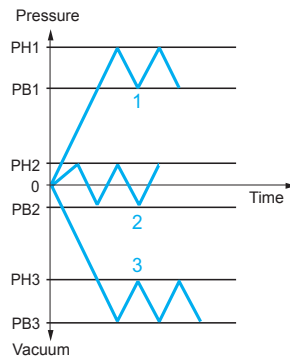

— Adjustable value

Connection

Terminal model



Connector model

Vacu-pressure switch pin view

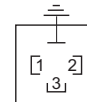

- 1 → 11 and 13
- 2 → 12
- 3 → 14

Other versions

For vacu-pressure switches with alternative tapped cable entries, such as NPT, etc. please consult our Customer Care Centre.

Electromechanical vacu-pressure switches

OsiSense XML. Size 5 bar (72.5 psi)
Adjustable differential, for regulation between 2 thresholds
Switches with 2 CO single-pole contacts

OsiSense XMLC vacu-pressure switches

With setting scale

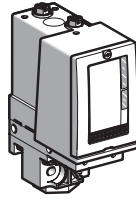

Adjustable range of switching point (PH) (Rising pressure)	- 0.55...5 bar (- 7.97...72.5 psi)
Electrical connection	Terminals
Fluid connection	G 1/4 (female)

References (1)

Fluids controlled (2)	Hydraulic oils, fresh water, air, up to + 160 °C	XMLCM05B2S12
	Corrosive fluids, up to + 160 °C	XMLCM05C2S12
Weight (kg)	0.685	

Complementary characteristics not shown under general characteristics (page 17)

Possible differential (subtract from PH to give PB)	Min. at low setting (3)	0.45 bar (6.52 psi)
	Min. at high setting (3)	0.45 bar (6.52 psi)
	Max. at high setting	6 bar (87 psi)
Maximum permissible pressure	Per cycle	6.25 bar (90.62 psi)
	Accidental	11.25 bar (163.12 psi)
Destruction pressure	23 bar (333.5 psi)	
Mechanical life	3 x 10 ⁹ operating cycles	
Cable entry for terminal models	1 entry tapped M20 x 1.5 mm for ISO cable gland, clamping capacity 7 to 13 mm	
Vacu-pressure switch type	Diaphragm	

(1) For 1 entry tapped for no. 13 cable gland, replace **S12** with **S11** (for example, **XMLCM05B2S12** becomes **XMLCM05B2S11**).

(2) For component materials of units in contact with the fluid, see pages 72 and 73.

(3) Deviation of the differential at low and high setting points for switches of the same size:
± 0.1 bar (± 1.45 psi).

Operating curves

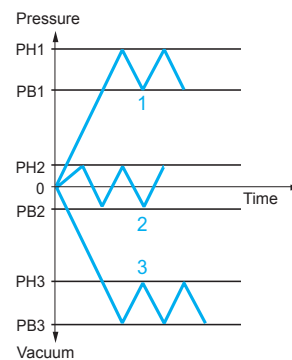
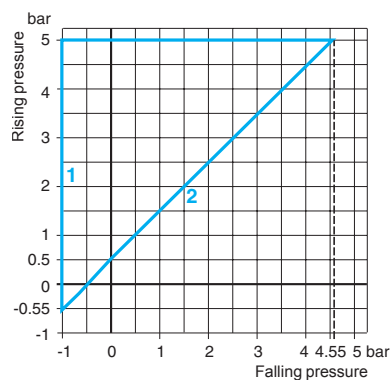

Connection

Terminal model

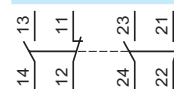

Connector model

Vacu-pressure switch pin view

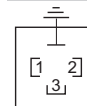

1 → 11 and 13
2 → 12
3 → 14

- 1 Maximum differential
- 2 Minimum differential

— Adjustable value

Other versions

For vacu-pressure switches with alternative tapped cable entries, such as NPT, etc. please consult our Customer Care Centre.

Electromechanical pressure switches

OsiSense XML

Size 350 mbar (5.07 psi)

Adjustable differential, for regulation between 2 thresholds

Switches with 1 CO single-pole contact

OsiSense XMLB pressure switches

With setting scale

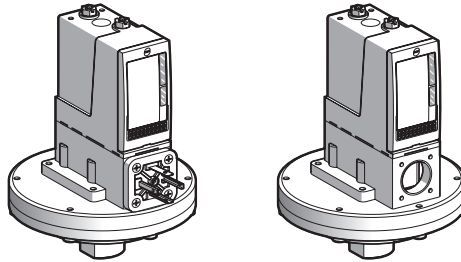

Adjustable range of switching point (PH) (Rising pressure)	45...350 mbar (0.65...5.07 psi)		
Electrical connection	DIN connector	Terminals	
Fluid connection	G 1/4 (female)	G 1/4 (female)	1/4"-18 NPTF (female)

References (1)

Fluids controlled (2)	Hydraulic oils, air, up to + 160 °C	XMLBL35R2C11	XMLBL35R2S12	XMLBL35R2S13
	Fresh water, corrosive fluids, up to + 160 °C	XMLBL35S2C11	XMLBL35S2S12	—
	Viscous products, up to + 160 °C (G 1 1/4" fluid connection)	XMLBL35P2C11	XMLBL35P2S12	—
Weight (kg)		2.590	2.575	2.575

Complementary characteristics not shown under general characteristics (page 17)

Possible differential (subtract from PH to give PB)	Min. at low setting (3)	42 mbar (0.60 psi)	
	Min. at high setting (4)	50 mbar (0.72 psi)	
	Max. at high setting	300 mbar (4.35 psi)	
Maximum permissible pressure	Per cycle	1.25 bar (18.12 psi)	
	Accidental	2.25 bar (32.62 psi)	
Destruction pressure		4.5 bar (65.25 psi)	
Mechanical life		4 million operating cycles	
Connection	EN 175301-803-A (ex-DIN 43650A), 4-pin male connector. For suitable female connector, see page 68	1 entry tapped M20 x 1.5 mm for ISO cable gland, clamping capacity 7 to 13 mm	1 entry tapped 1/2"-14 NPT for cable gland, clamping capacity 7 to 13 mm
	Pressure switch type	Diaphragm	

(1) For 1 entry tapped for no. 13 cable gland, replace S12 with S11 (for example, XMLBL35R2S12 becomes XMLBL35R2S11).

(2) For component materials of units in contact with the fluid, see pages 72 and 73.

(3) Deviation of the differential at low setting point for switches of the same size:
- 8 mbar, + 3 mbar (- 0.12 psi, + 0.04 psi).

(4) Deviation of the differential at high setting point for switches of the same size:
± 8 mbar (± 0.11 psi).

Operating curves

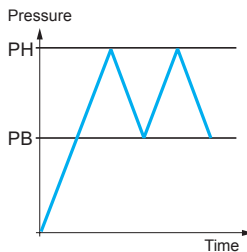
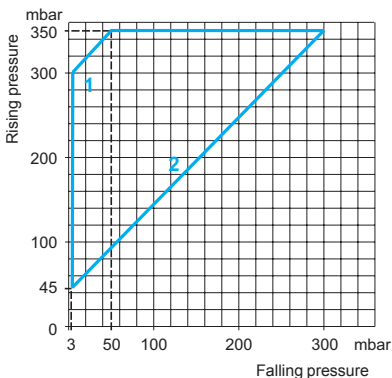

Connection

Terminal model



Connector model

Pressure switch connector pin view

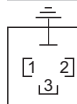

1 → 11 and 13
2 → 12
3 → 14

- 1 Maximum differential
- 2 Minimum differential

Other versions

For pressure switches with alternative tapped cable entries, such as NPT, etc. please consult our Customer Care Centre.

Electromechanical pressure switches

OsiSense XML

Size 350 mbar (5.07 psi)

Adjustable differential, for regulation between 2 thresholds

Switches with 1 CO single-pole contact

OsiSense XMLB pressure switches

30 bar (435 psi) overpressure
With setting scale

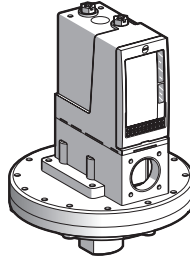

Adjustable range of switching point (PH) (Rising pressure)	42...330 mbar (0.61...4.78 psi)
Electrical connection	Terminals
Fluid connection	G 1/4 (female)

References (1)

Fluids controlled (2)	Hydraulic oils, air, up to + 160 °C	XMLBS35R2S12
Weight (kg)		3.500

Complementary characteristics not shown under general characteristics (page 17)

Possible differential (subtract from PH to give PB)	Min. at low setting (3)	33 mbar (0.48 psi)
	Min. at high setting (4)	58 mbar (0.84 psi)
	Max. at high setting	250 mbar (3.62 psi)
Maximum permissible pressure	Per cycle	30 bar (435 psi)
	Accidental	37.5 bar (543.75 psi)
Destruction pressure		67.5 bar (978.75 psi)
Mechanical life		2 million operating cycles
Cable entry for terminal models		1 entry tapped M20 x 1.5 mm for ISO cable gland, clamping capacity 7 to 13 mm
Connector type for connector models		EN 175301-803-A (ex-DIN 43650A), 4-pin male connector. For suitable female connector, see page 68
Pressure switch type		Diaphragm

(1) For 1 entry tapped for no. 13 cable gland, replace S12 with S11 (for example, XMLBS35R1S12 becomes XMLBS35R1S11).

(2) For component materials of units in contact with the fluid, see pages 72 and 73.

(3) Deviation of the differential at low setting point for switches of the same size:
- 8 mbar, + 3 mbar (- 0.12 psi, + 0.04 psi).

(4) Deviation of the differential at high setting point for switches of the same size:
± 8 mbar (± 0.11 psi).

Operating curves

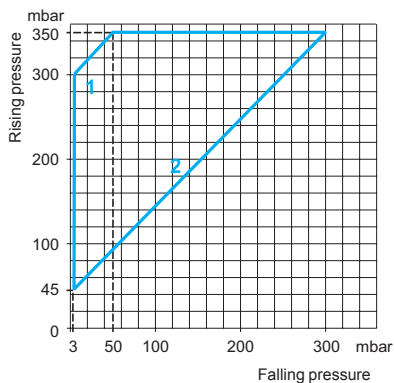

- 1 Maximum differential
- 2 Minimum differential

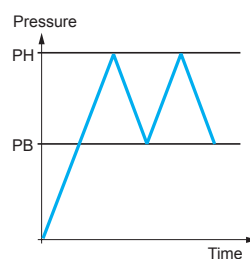

— Adjustable value

Connection

Terminal model



Connector model

Pressure switch connector pin view

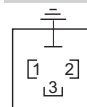

- 1 → 11 and 13
- 2 → 12
- 3 → 14

Other versions

For pressure switches with alternative tapped cable entries, such as NPT, etc. please consult our Customer Care Centre.

Electromechanical pressure switches

OsiSense XML

Size 350 mbar (5.07 psi)

Adjustable differential, for regulation between 2 thresholds

Switches with 2 CO single-pole contacts

OsiSense XMLC pressure switches	With setting scale	30 bar (435 psi) overpressure With setting scale
---------------------------------	--------------------	---

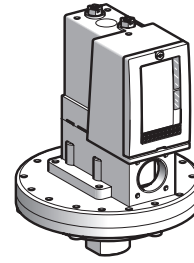
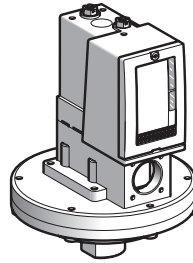

Adjustable range of switching point (PH) (Rising pressure)	45...350 mbar (0.65...5.07 psi)		42...330 mbar (0.61...4.78 psi)	
Electrical connection	Terminals		Terminals	
Fluid connection	G 1/4 (female)	1/4"-18 NPTF (female)	G 1/4 (female)	1/4"-18 NPTF (female)

References (1)

Fluids controlled (2)	Hydraulic oils, air, up to + 160 °C	XMLCL35R2S12	—	XMLCS35R2S12	XMLCS35R2S13
	Fresh water, corrosive fluids, up to + 160 °C	XMLCL35S2S12	XMLCL35S2S13	—	—
Weight (kg)		2.575	2.575	3.500	3.500

Complementary characteristics not shown under general characteristics (page 17)

Possible differential (subtract from PH to give PB)	Min. at low setting (3)	20 mbar (0.29 psi)	40 mbar (0.58 psi)		
	Min. at high setting (3)	35 mbar (0.51 psi)	88 mbar (1.27 psi)		
	Max. at high setting	300 mbar (4.35 psi)	230 mbar (3.33 psi)		
Maximum permissible pressure	Per cycle	1.25 bar (18.12 psi)	30 bar (435 psi)		
	Accidental	2.25 bar (32.62 psi)	37.5 bar (543.75 psi)		
Destruction pressure		4.5 bar (65.25 psi)	67.5 bar (978.75 psi)		
Mechanical life		4 million operating cycles	2 million operating cycles		
Cable entry for terminal models		1 entry tapped M20 x 1.5 mm for ISO cable gland, clamping capacity 7 to 13 mm	1 entry tapped 1/2"-14 NPT for cable gland, clamping capacity 7 to 13 mm	1 entry tapped M20 x 1.5 mm for ISO cable gland, clamping capacity 7 to 13 mm	1 entry tapped 1/2"-14 NPT for cable gland, clamping capacity 7 to 13 mm
Pressure switch type		Diaphragm			

(1) For 1 entry tapped for no. 13 cable gland, replace S12 with S11 (for example, XMLCL35R2S12 becomes XMLCL35R2S11).

(2) For component materials of units in contact with the fluid, see pages 72 and 73.

(3) Deviation of the differential at low setting point for switches of the same size:
± 20 mbar (± 0.29 psi).

Operating curves

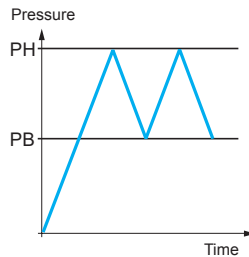
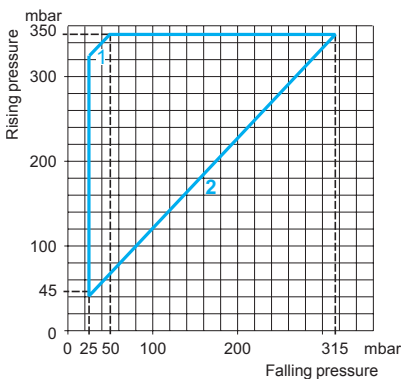

Connection

Terminal model

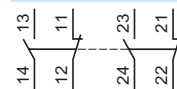

- 1 Maximum differential
- 2 Minimum differential

— Adjustable value

Other versions

For pressure switches with alternative tapped cable entries, such as NPT, etc. please consult our Customer Care Centre.

Electromechanical pressure switches

OsiSense XML

Size 350 mbar (5.07 psi)

Dual stage, fixed differential, for detection at each threshold

Switches with 2 CO single-pole contacts

OsiSense XMLD pressure switches

Without setting scale

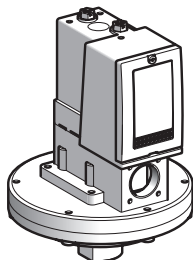

Adjustable range of each switching point (Rising pressure)	2nd stage switching point (PH2) 1st stage switching point (PH1)	58...350 mbar (0.84...5.07 psi) 33...325 mbar (0.48...4.71 psi)
Spread between 2 stages (PH2 - PH1)		25...310 mbar (0.36...4.50 psi)
Electrical connection		Terminals
Fluid connection		G 1/4 (female)

References (1)

Fluids controlled (2)	Hydraulic oils, air, up to + 160 °C	XMLDL35R1S12
Weight (kg)		2.575

Complementary characteristics not shown under general characteristics (page 17)

Natural differential (subtract from PH1/PH2 to give PB1/PB2)	At low setting (3) At high setting (4)	30 mbar (0.44 psi) 30 mbar (0.44 psi)
Maximum permissible pressure	Per cycle Accidental	1.25 bar (18.12 psi) 2.25 bar (32.62 psi)
Destruction pressure		4.5 bar (65.25 psi)
Mechanical life		4 million operating cycles
Cable entry for terminal models		1 entry tapped M20 x 1.5 mm for ISO cable gland, clamping capacity 7 to 13 mm
Pressure switch type		Diaphragm

(1) For 1 entry tapped for no. 13 cable gland, replace S12 with S11 (for example, XMLDL35R1S12 becomes XMLDL35R1S11).

(2) For component materials of units in contact with the fluid, see pages 72 and 73.

(3) Deviation of the differential at low setting point for switches of the same size:
± 10 mbar (± 0.15 psi).

(4) Deviation of the differential at high setting point for switches of the same size:
± 8 mbar (± 0.11 psi).

Operating curves

High setting tripping points of contacts 1 and 2

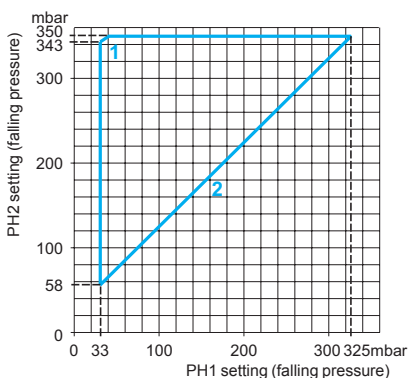

- 1 Maximum differential
- 2 Minimum differential

Natural differential of contacts 1 and 2

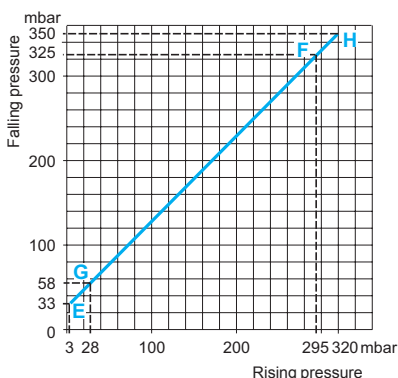

- EF Contact 1 (stage 1)
- GH Contact 2 (stage 2)

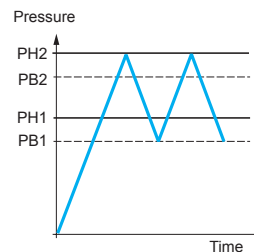

— Adjustable value
--- Non adjustable value

Connection

Terminal model

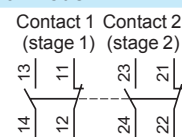

Other versions

For pressure switches with alternative tapped cable entries, such as NPT, etc. please consult our Customer Care Centre.

Electromechanical pressure switches

OsiSense XML

Size 1 bar (14.5 psi)

Fixed differential, for detection of a single threshold

Switches with 1 CO single-pole contact

OsiSense XMLA pressure switches

With setting scale

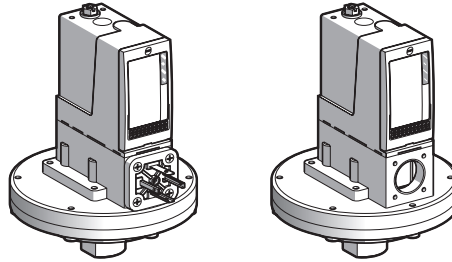

Adjustable range of switching point (PH) (Rising pressure)	0.03...1 bar (0.435...14.5 psi)			
Electrical connection	DIN connector	Terminals		
Fluid connection	G 1/4 (female)	G 1/4 (female)	1/4"-18 NPTF (female)	
References (1)				
Fluids controlled (2)	Hydraulic oils, air, up to + 160 °C	XMLA001R2C11	XMLA001R2S12	—
	Fresh water, corrosive fluids, up to + 160 °C	XMLA001S2C11	XMLA001S2S12	XMLA001S2S13
Weight (kg)	2.570	2.555	2.555	
Complementary characteristics not shown under general characteristics (page 17)				
Natural differential (subtract from PH to give PB)	At low setting (3)	0.02 bar (0.29 psi)		
	At high setting (3)	0.04 bar (0.58 psi)		
Maximum permissible pressure	Per cycle	1.25 bar (18.12 psi)		
	Accidental	2.25 bar (32.62 psi)		
Destruction pressure	4.5 bar (65.25 psi)			
Mechanical life	4 x 10 ⁶ operating cycles			
Connection	EN 175301-803-A (ex-DIN 43650A), 4-pin male connector. For suitable female connector, see page 68	1 entry tapped M20 x 1.5 mm for ISO cable gland, clamping capacity 7 to 13 mm	1 entry tapped 1/2"-14 NPT for cable gland, clamping capacity 7 to 13 mm	
Pressure switch type	Diaphragm			

(1) For 1 entry tapped for no. 13 cable gland, replace S12 with S11 (for example, XMLA001R2S12 becomes XMLA001R2S11).

(2) For component materials of units in contact with the fluid, see pages 72 and 73.

(3) Deviation of the differential at low and high setting points for switches of the same size:
± 0.01 bar (± 0.14 psi)

Operating curves

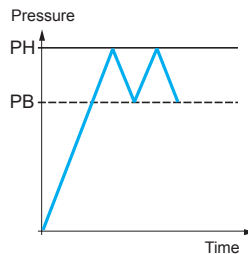
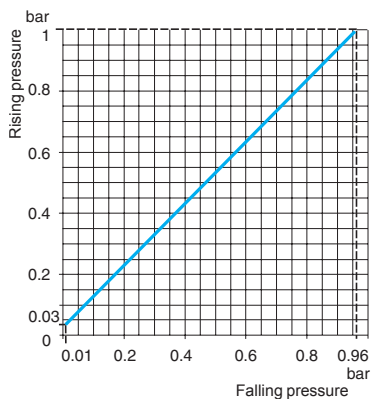

Connection

Terminal model



Connector model

Pressure switch connector pin view

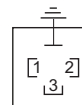

1 → 11 and 13
2 → 12
3 → 14

— Adjustable value

--- Non adjustable value

Other versions

For pressure switches with alternative tapped cable entries, such as NPT, etc. please consult our Customer Care Centre.

Electromechanical pressure switches

OsiSense XML

Size 1 bar (14.5 psi)

Adjustable differential, for regulation between 2 thresholds

Switches with 1 CO single-pole contact

OsiSense XMLB pressure switches

With setting scale

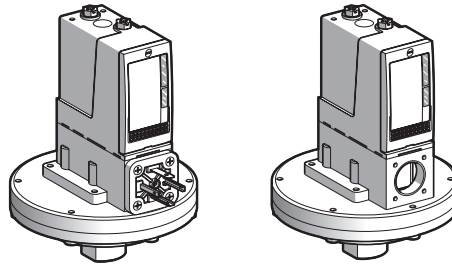

Adjustable range of switching point (PH) (Rising pressure)	0.05...1 bar (0.72...14.5 psi)		
Electrical connection	DIN connector	Terminals	
Fluid connection	G 1/4 (female)	G 1/4 (female)	1/4"-18 NPTF (female)
References (1)			
Fluids controlled (2)	Hydraulic oils, air, up to + 160 °C	XMLB001R2C11	XMLB001R2S12
	Fresh water, corrosive fluids, up to + 160 °C	XMLB001S2C11	XMLB001S2S12
	Viscous products, up to + 160 °C (G 1/4" fluid connection)	—	XMLB001P2S12
Weight (kg)	2.590	2.575	2.575
Complementary characteristics not shown under general characteristics (page 17)			
Possible differential (subtract from PH to give PB)	Min. at low setting (3)	0.04 bar (0.58 psi)	
	Min. at high setting (4)	0.06 bar (0.87 psi)	
	Max. at high setting	0.75 bar (10.87 psi)	
Maximum permissible pressure	Per cycle	1.25 bar (18.12 psi)	
	Accidental	2.25 bar (32.62 psi)	
Destruction pressure		4.5 bar (65.25 psi)	
Mechanical life		4 x 10 ⁸ operating cycles	
Connection		EN 175301-803-A (ex-DIN 43650A), 4-pin male connector. For suitable female connector, see page 68	1 entry tapped M20 x 1.5 mm for ISO cable gland, clamping capacity 7 to 13 mm
			1 entry tapped 1/2"-14 NPT for cable gland, clamping capacity 7 to 13 mm
Pressure switch type		Diaphragm	

(1) For 1 entry tapped for no. 13 cable gland, replace S12 with S11 (for example, XMLB001R2S12 becomes XMLB001R2S11).

(2) For component materials of units in contact with the fluid, see pages 72 and 73.

(3) Deviation of the differential at low setting point for switches of the same size:
± 10 mbar (± 0.14 psi).

(4) Deviation of the differential at high setting point for switches of the same size:
± 20 mbar (± 0.29 psi).

Operating curves

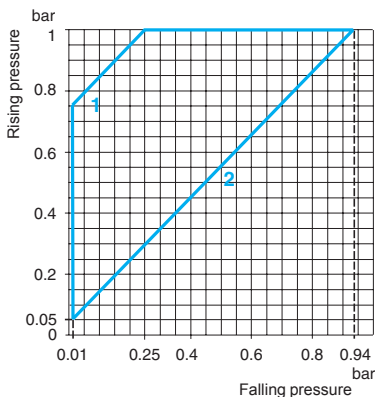

- 1 Maximum differential
- 2 Minimum differential

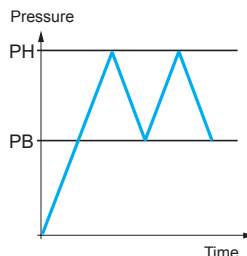

— Adjustable value

Connection

Terminal model



Connector model

Pressure switch connector pin view

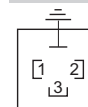

- 1 → 11 and 13
- 2 → 12
- 3 → 14

Other versions

For pressure switches with alternative tapped cable entries, such as NPT, etc. please consult our Customer Care Centre.

Electromechanical pressure switches

OsiSense XML

Size 1 bar (14.5 psi)

Adjustable differential, for regulation between 2 thresholds

Switches with 2 CO single-pole contacts

OsiSense XMLC pressure switches

With setting scale

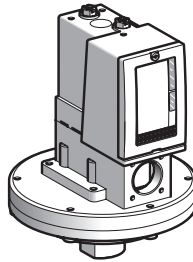

Adjustable range of switching point (PH) (Rising pressure)	0.05...1 bar (0.725...14.5 psi)	
Electrical connection	Terminals	
Fluid connection	G 1/4 (female)	1/4"-18 NPTF (female)

References (1)

Fluids controlled (2)	Hydraulic oils, air, up to + 160 °C	XMLC001R2S12	XMLC001R2S13
	Fresh water, corrosive fluids, up to + 160 °C	XMLC001S2S12	XMLC001S2S13
Weight (kg)	2.555		2.555

Complementary characteristics not shown under general characteristics (page 17)

Possible differential (subtract from PH to give PB)	Min. at low setting (3)	0.03 bar (0.43 psi)	
	Min. at high setting (4)	0.04 bar (0.58 psi)	
	Max. at high setting	0.8 bar (11.6 psi)	
Maximum permissible pressure	Per cycle	1.25 bar (18.12 psi)	
	Accidental	2.25 bar (32.62 psi)	
Destruction pressure	4.5 bar (65.25 psi)		
Mechanical life	4 x 10 ⁶ operating cycles		
Cable entry for terminal models	1 entry tapped M20 x 1.5 mm for ISO cable gland, clamping capacity 7 to 13 mm		1 entry tapped 1/2"-14 NPT for cable gland, clamping capacity 7 to 13 mm
Pressure switch type	Diaphragm		

- (1) For 1 entry tapped for no. 13 cable gland, replace S12 with S11 (for example, XMLC001R2S12 becomes XMLC001R2S11).
- (2) For component materials of units in contact with the fluid, see pages 72 and 73.
- (3) Deviation of the differential at low setting point for switches of the same size:
± 0.01 bar (± 0.14 psi)
- (4) Deviation of the differential at high setting point for switches of the same size:
± 0.03 bar (± 0.43 psi)

Operating curves

Connection

Terminal model

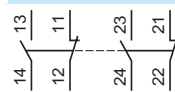
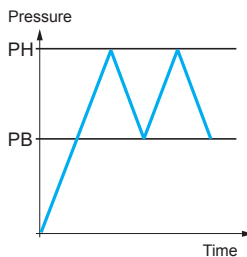
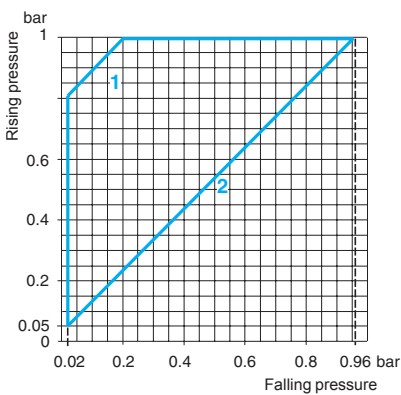

- 1 Maximum differential
- 2 Minimum differential

— Adjustable value

Other versions

For pressure switches with alternative tapped cable entries, such as NPT, etc. please consult our Customer Care Centre.

OsiSense XML

Size 2.5 bar (36.25 psi)

Fixed differential, for detection of a single threshold

Switches with 1 CO single-pole contact

OsiSense XMLA pressure switches

With setting scale

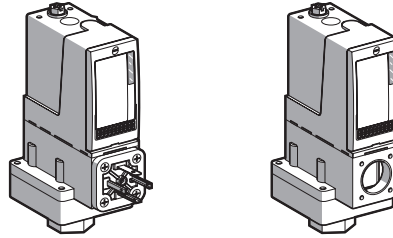

Adjustable range of switching point (PH) (Rising pressure)	0.15...2.5 bar (2.17...36.25 psi)		
Electrical connection	DIN connector	Terminals	
Fluid connection	G 1/4 (female)	G 1/4 (female)	1/4"-18 NPTF (female)

References (1)

Fluids controlled (2)	Hydraulic oils, fresh water, air, up to + 70 °C	XMLA002A2C11	XMLA002A2S12	XMLA002A2S13
	Hydraulic oils, fresh water, air, up to + 160 °C	XMLA002B2C11	XMLA002B2S12	—
	Corrosive fluids, up to + 160 °C	XMLA002C2C11	XMLA002C2S12	—
Weight (kg)		1.010	0.995	0.995

Complementary characteristics not shown under general characteristics (page 17)

Natural differential (subtract from PH to give PB)	At low setting (3)	0.13 bar (1.88 psi)
	At high setting (3)	0.13 bar (1.88 psi)
Maximum permissible pressure	Per cycle	5 bar (72.5 psi)
	Accidental	9 bar (130.5 psi)
Destruction pressure		18 bar (261 psi)
Mechanical life		8 x 10 ⁸ operating cycles
Connection		EN 175301-803-A (ex-DIN 43650A), 4-pin male connector. For suitable female connector, see page 68
Pressure switch type		1 entry tapped M20 x 1.5 mm for ISO cable gland, clamping capacity 7 to 13 mm
		1 entry tapped 1/2"-14 NPT for cable gland, clamping capacity 7 to 13 mm

(1) For 1 entry tapped for no. 13 cable gland, replace S12 with S11 (for example, XMLA002A2S12 becomes XMLA002A2S11).

(2) For component materials of units in contact with the fluid, see pages 72 and 73.

(3) Deviation of the differential at low and high setting points for switches of the same size: ± 0.03 bar (± 0.43 psi).

Operating curves

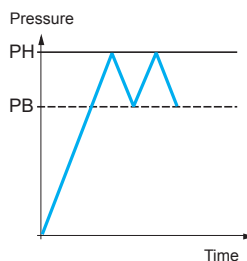
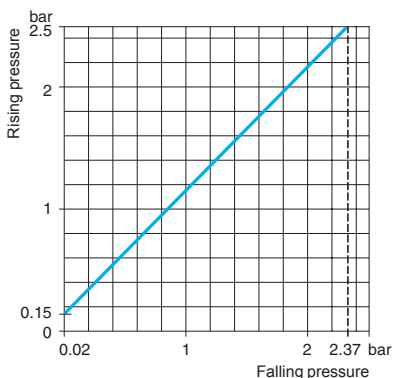

Connection

Terminal model



Connector model

Pressure switch connector pin view

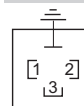

1 → 11 and 13
2 → 12
3 → 14

— Adjustable value
--- Non adjustable value

Other versions

For pressure switches with alternative tapped cable entries, such as NPT, etc. please consult our Customer Care Centre.

Electromechanical pressure switches

OsiSense XML

Size 2.5 bar (36.25 psi)

Adjustable differential, for regulation between 2 thresholds

Switches with 1 CO single-pole contact

OsiSense XMLB pressure switches	With setting scale	30 bar (435 psi) overpressure With setting scale
---------------------------------	--------------------	---

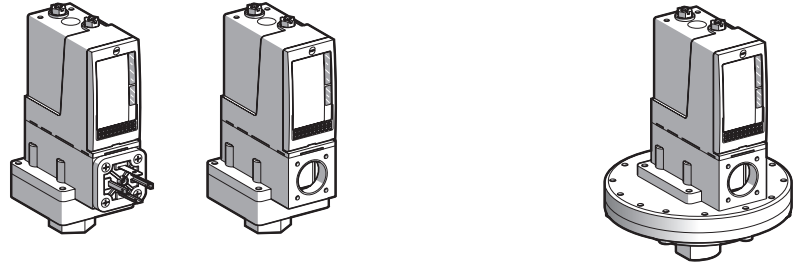

Adjustable range of switching point (PH) (Rising pressure)	0.3...2.5 bar (4.35...36.25 psi)			
Electrical connection	DIN connector	Terminals		
Fluid connection	G 1/4 (female)	G 1/4 (female)	1/4"-18 NPTF (female)	G 1/4 (female)

References (1)					
Fluids controlled (2)	Hydraulic oils, fresh water, air, up to + 70 °C	XMLB002A2C11	XMLB002A2S12	XMLB002A2S13	—
	Hydraulic oils, fresh water, air, up to + 160 °C	XMLB002B2C11	XMLB002B2S12	—	XMLBS02B2S12
	Corrosive fluids, up to + 160 °C	XMLB002C2C11	XMLB002C2S12	—	—
Weight (kg)	1.030	1.015	1.015	3.500	

Complementary characteristics not shown under general characteristics (page 17)					
Possible differential (subtract from PH to give PB)	Min. at low setting (3)	0.16 bar (2.32 psi)		0.1 bar (1.45 psi)	
	Min. at high setting (3)	0.21 bar (3.04 psi)		0.22 bar (3.19 psi)	
	Max. at high setting	1.75 bar (25.37 psi)		1.45 bar (21 psi)	
Maximum permissible pressure	Per cycle	5 bar (72.5 psi)		30 bar (435 psi)	
	Accidental	9 bar (130.5 psi)		37.5 bar (543.75 psi)	
Destruction pressure		18 bar (261 psi)		67.5 bar (978.75 psi)	
Mechanical life		8 x 10 ⁶ operating cycles		2 x 10 ⁶ operating cycles	
Connection		EN 175301-803-A (ex-DIN 43650A), 4-pin male connector. For suitable female connector, see page 68	1 entry tapped M20 x 1.5 mm for ISO cable gland, clamping capacity 7 to 13 mm	1 entry tapped 1/2"-14 NPT for cable gland, clamping capacity 7 to 13 mm	1 entry tapped M20 x 1.5 mm for ISO cable gland, clamping capacity 7 to 13 mm
Pressure switch type		Diaphragm			

(1) For 1 entry tapped for no. 13 cable gland, replace S12 with S11 (for example, XMLB002A2S12 becomes XMLB002A2S11).

(2) For component materials of units in contact with the fluid, see pages 72 and 73.

(3) Deviation of the differential at low and high setting points for switches of the same size:
- 0.03 bar, + 0.05 bar (- 0.43 psi, + 0.72 psi).

Operating curves

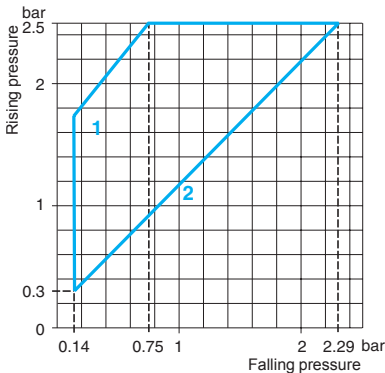

- 1 Maximum differential
- 2 Minimum differential

Other versions

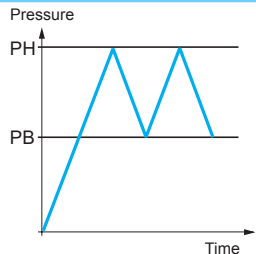

— Adjustable value

Connection

Terminal model



Connector model

Pressure switch connector pin view

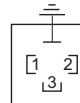

- 1 → 11 and 13
- 2 → 12
- 3 → 14

For pressure switches with alternative tapped cable entries, such as NPT, etc. please consult our Customer Care Centre.

Electromechanical pressure switches

OsiSense XML

Size 2.5 bar (36.25 psi)

Adjustable differential, for regulation between 2 thresholds

Switches with 2 CO single-pole contacts

OsiSense XMLC pressure switches	With setting scale	30 bar (435 psi) overpressure With setting scale
---------------------------------	--------------------	---

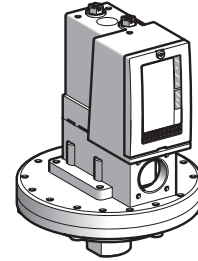
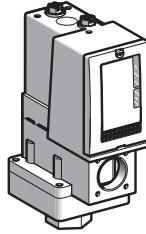

Adjustable range of switching point (PH) (Rising pressure)	0.3...2.5 bar (4.35...36.25 psi)			
Electrical connection	Terminals			
Fluid connection	G 1/4 (female)	1/4"-18 NPTF (female)	G 1/4 (female)	1/4"-18 NPTF (female)

References (1)					
Fluids controlled (2)	Hydraulic oils, fresh water, air, up to + 160 °C	XMLC002B2S12	XMLC002B2S13	XMLCS02B2S12	XMLCS02B2S13
Weight (kg)		0.995	0.995	3.500	3.500

Complementary characteristics not shown under general characteristics (page 17)					
Possible differential (subtract from PH to give PB)	Min. at low setting (3)	0.13 bar (1.89 psi)		0.1 bar (1.45 psi)	
	Min. at high setting (4)	0.17 bar (2.47 psi)		0.18 bar (2.61 psi)	
	Max. at high setting	2 bar (29 psi)		1.25 bar (18.12 psi)	
Maximum permissible pressure	Per cycle	5 bar (72.5 psi)		30 bar (435 psi)	
	Accidental	9 bar (130.5 psi)		37.5 bar (543.75 psi)	
Destruction pressure		18 bar (261 psi)		67.5 bar (978.75 psi)	
Mechanical life		8 x 10 ⁸ operating cycles		2 x 10 ⁸ operating cycles	
Cable entry for terminal models		1 entry tapped M20 x 1.5 mm for ISO cable gland, clamping capacity 7 to 13 mm	1 entry tapped 1/2"-14 NPT for cable gland, clamping capacity 7 to 13 mm	1 entry tapped M20 x 1.5 mm for ISO cable gland, clamping capacity 7 to 13 mm	1 entry tapped 1/2"-14 NPT for cable gland, clamping capacity 7 to 13 mm
Pressure switch type		Diaphragm			

- (1) For 1 entry tapped for no. 13 cable gland, replace **S12** with **S11** (for example, **XMLC002B2S12** becomes **XMLC002B2S11**).
- (2) For component materials of units in contact with the fluid, see pages 72 and 73.
- (3) Deviation of the differential at low setting point for switches of the same size:
± 0.02 bar (± 0.29 psi)
- (4) Deviation of the differential at high setting point for switches of the same size:
± 0.03 bar (± 0.43 psi)

Operating curves

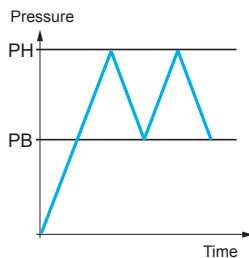
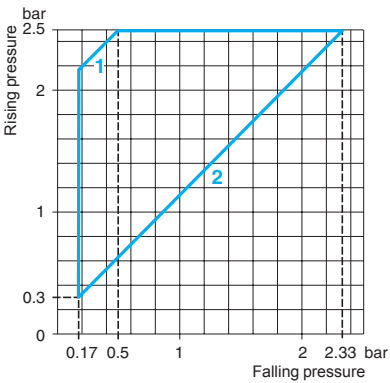

Connection



- 1 Maximum differential
2 Minimum differential

— Adjustable value

Other versions For pressure switches with alternative tapped cable entries, such as NPT, etc. please consult our Customer Care Centre.

Electromechanical pressure switches

OsiSense XML

Size 4 bar (58 psi)

Fixed differential, for detection of a single threshold

Switches with 1 CO single-pole contact

OsiSense XMLA pressure switches

With setting scale

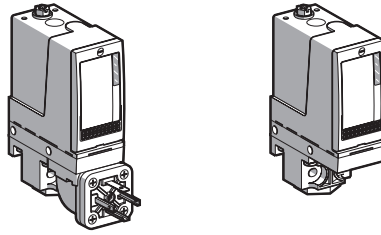

Adjustable range of switching point (PH) (Rising pressure)	0.4...4 bar (5.8...58 psi)			
Electrical connection	DIN connector	Terminals		
Fluid connection	G 1/4 (female)	G 1/4 (female)	1/4"-18 NPTF (female)	
References (1)				
Fluids controlled (2)	Hydraulic oils, fresh water, air, up to + 70 °C	XMLA004A2C11	XMLA004A2S12	XMLA004A2S13
	Hydraulic oils, fresh water, air, up to + 160 °C	XMLA004B2C11	XMLA004B2S12	—
	Corrosive fluids, up to + 160 °C Sea water, up to + 30 °C	XMLA004C2C11	XMLA004C2S12	—
	Viscous products, up to + 160 °C (G 1 1/4" fluid connection)	XMLA004P2C11	XMLA004P2S12	—
Weight (kg)		0.715	0.685	0.685

Complementary characteristics not shown under general characteristics (page 17)

Natural differential (subtract from PH to give PB)	At low setting (3)	0.35 bar (5.07 psi)		
	At high setting (3)	0.35 bar (5.07 psi)		
Maximum permissible pressure	Per cycle	5 bar (72.5 psi)		
	Accidental	9 bar (130.5 psi)		
Destruction pressure		18 bar (261 psi)		
Mechanical life		8 x 10 ⁶ operating cycles		
Connection		EN 175301-803-A (ex-DIN 43650A), 4-pin male connector. For suitable female connector, see page 68	1 entry tapped M20 x 1.5 mm for ISO cable gland, clamping capacity 7 to 13 mm	1 entry tapped 1/2"-14 NPT for cable gland, clamping capacity 7 to 13 mm
Pressure switch type		Diaphragm		

(1) For 1 entry tapped for no. 13 cable gland, replace **S12** with **S11** (for example, **XMLA004A2S12** becomes **XMLA004A2S11**).

(2) For component materials of units in contact with the fluid, see pages 72 and 73.

(3) Deviation of the differential at low and high setting points for switches of the same size: ± 0.03 bar (± 0.43 psi)

Operating curves

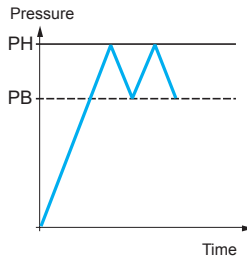
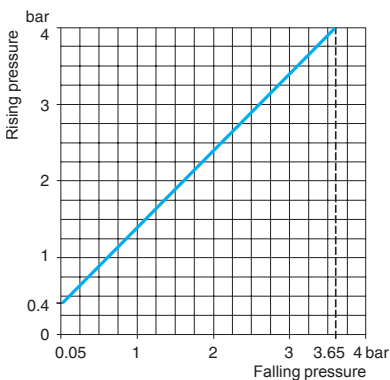

Connection

Terminal model



Connector model

Pressure switch connector pin view

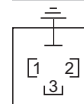

1 → 11 and 13

2 → 12

3 → 14

— Adjustable value

--- Non adjustable value

Other versions

For pressure switches with alternative tapped cable entries, such as NPT, etc. please consult our Customer Care Centre.

Electromechanical pressure switches

OsiSense XML

Size 4 bar (58 psi)

Adjustable differential, for regulation between 2 thresholds

Switches with 1 CO single-pole contact

OsiSense XMLB pressure switches	With setting scale	30 bar (435 psi) overpressure With setting scale
---------------------------------	--------------------	--

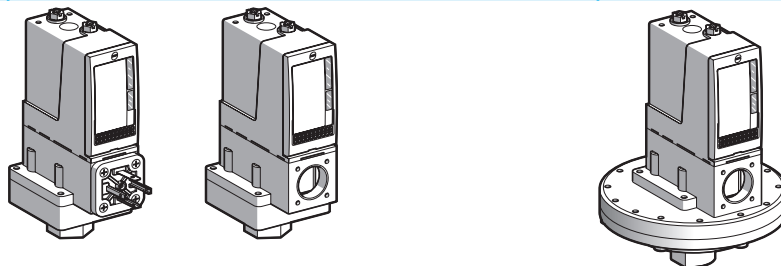

Adjustable range of switching point (PH) (Rising pressure)	0.25...4 bar (3.62...58 psi)			
Electrical connection	DIN connector	Terminals		
Fluid connection	G 1/4 (female)	G 1/4 (female)	1/4"-18 NPTF (female)	G 1/4 (female)

References (1)					
Fluids controlled (2)	Hydraulic oils, fresh water, air, up to + 70 °C	XMLB004A2C11	XMLB004A2S12	XMLB004A2S13	—
	Hydraulic oils, fresh water, air, up to + 160 °C	XMLB004B2C11	XMLB004B2S12	—	XMLBS04B2S12
	Corrosive fluids, up to + 160 °C	XMLB004C2C11	XMLB004C2S12	—	—
Weight (kg)		1.030	1.015	1.015	3.500

Complementary characteristics not shown under general characteristics (page 17)

Possible differential (subtract from PH to give PB)	Min. at low setting (3)	0.2 bar (2.9 psi)			0.15 bar (2.18 psi)
	Min. at high setting (4)	0.25 bar (3.62 psi)			0.34 bar (4.93 psi)
	Max. at high setting	2.4 bar (34.8 psi)			2.46 bar (35.67 psi)
Maximum permissible pressure	Per cycle	5 bar (72.5 psi)			30 bar (435 psi)
	Accidental	9 bar (130.5 psi)			37.5 bar (543.75 psi)
Destruction pressure		18 bar (261 psi)			67.5 bar (978.75 psi)
Mechanical life		8 x 10 ⁶ operating cycles			2 x 10 ⁶ operating cycles
Connection		EN 175301-803-A (ex-DIN 43650A), 4-pin male connector. For suitable female connector, see page 68	1 entry tapped M20 x 1.5 mm for ISO cable gland, clamping capacity 7 to 13 mm	1 entry tapped 1/2"-14 NPT for cable gland, clamping capacity 7 to 13 mm	1 entry tapped M20 x 1.5 mm for ISO cable gland, clamping capacity 7 to 13 mm
		Pressure switch type	Diaphragm		

(1) For 1 entry tapped for no. 13 cable gland, replace S12 with S11 (for example, XMLB004A2S12 becomes XMLB004A2S11).

(2) For component materials of units in contact with the fluid, see pages 72 and 73.

(3) Deviation of the differential at low setting point for switches of the same size:
± 0.01 bar (± 0.14 psi).

(4) Deviation of the differential at high setting point for switches of the same size:
- 0.03 bar, + 0.05 bar (- 0.43 psi, + 0.72 psi).

Operating curves

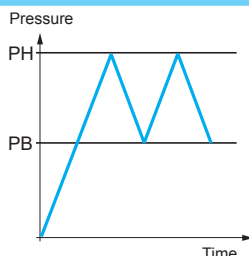
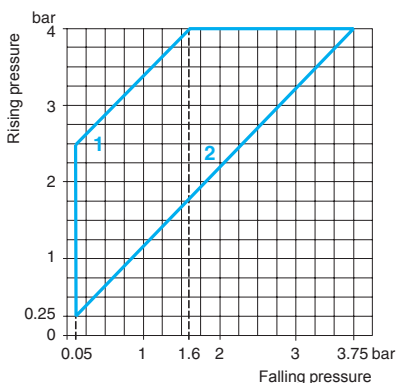

Connection

Terminal model



Connector model

Pressure switch connector pin view

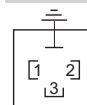

1 → 11 and 13
2 → 12
3 → 14

- 1 Maximum differential
- 2 Minimum differential

— Adjustable value

Other versions

For pressure switches with alternative tapped cable entries, such as NPT, etc. please consult our Customer Care Centre.

Electromechanical pressure switches

OsiSense XML

Size 4 bar (58 psi)

Adjustable differential, for regulation between 2 thresholds

Switches with 2 CO single-pole contacts

OsiSense XMLC pressure switches

With setting scale

30 bar (435 psi)
overpressure
With setting scale

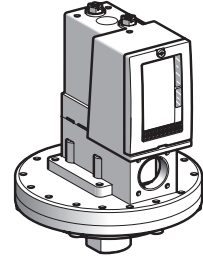
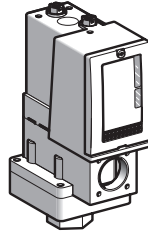

Adjustable range of switching point (PH) (Rising pressure)	0.3...4 bar (4.35...58 psi)		
Electrical connection	Terminals		
Fluid connection	G 1/4 (female)	1/4"-18 NPTF (female)	G 1/4 (female)

References (1)

Fluids controlled (2)	Hydraulic oils, fresh water, air, up to + 160 °C	XMLC004B2S12	XMLC004B2S13	XMLCS04B2S12
	Corrosive fluids, up to + 160 °C	XMLC004C2S12	XMLC004C2S13	—
Weight (kg)		0.685	0.685	3.500

Complementary characteristics not shown under general characteristics (page 17)

Possible differential (subtract from PH to give PB)	Min. at low setting (3)	0.15 bar (2.18 psi)	0.1 bar (1.45 psi)	
	Min. at high setting (3)	0.17 bar (2.47 psi)	0.25 bar (3.62 psi)	
	Max. at high setting	2.5 bar (36.25 psi)	2.20 bar (31.9 psi)	
Maximum permissible pressure	Per cycle	5 bar (72.5 psi)	30 bar (435 psi)	
	Accidental	9 bar (130.5 psi)	37.5 bar (543.75 psi)	
Destruction pressure		18 bar (261 psi)	67.5 bar (978.75 psi)	
Mechanical life		8 x 10 ⁶ operating cycles	2 x 10 ⁶ operating cycles	
Cable entry for terminal models		1 entry tapped M20 x 1.5 mm for ISO cable gland, clamping capacity 7 to 13 mm	1 entry tapped 1/2"-14 NPT for cable gland, clamping capacity 7 to 13 mm	1 entry tapped M20 x 1.5 mm for ISO cable gland, clamping capacity 7 to 13 mm
Pressure switch type		Diaphragm		

(1) For 1 entry tapped for no. 13 cable gland, replace S12 with S11 (for example, XMLC004B2S12 becomes XMLC004B2S11).

(2) For component materials of units in contact with the fluid, see pages 72 and 73.

(3) Deviation of the differential at low and high setting points for switches of the same size: ± 0.02 bar (± 0.29 psi).

Operating curves

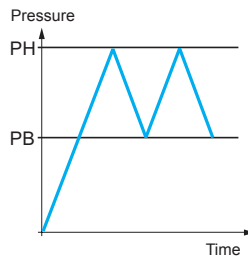
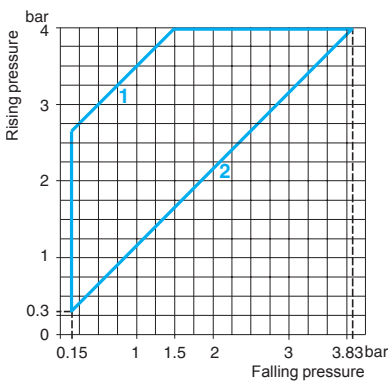

Connection

Terminal model

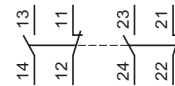

- 1 Maximum differential
- 2 Minimum differential

— Adjustable value

Other versions

For pressure switches with alternative tapped cable entries, such as NPT, etc. please consult our Customer Care Centre.

OsiSense XMLD pressure switches

Without setting scale

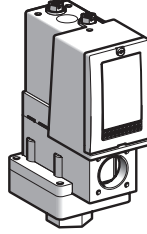

Adjustable range of each switching point (Rising pressure)	2nd stage switching point (PH2)	0.40...4 bar (5.8...58 psi)
	1st stage switching point (PH1)	0.19...3.79 bar (2.76...54.96 psi)
Spread between 2 stages (PH2 - PH1)		0.21...2.18 bar (3.05...31.61 psi)
Electrical connection		Terminals
Fluid connection		G 1/4 (female)

References (1)

Fluids controlled (2)	Hydraulic oils, fresh water, air, up to + 160 °C	XMLD004B1S12
Weight (kg)		1.015

Complementary characteristics not shown under general characteristics (page 17)

Natural differential (subtract from PH1/PH2 to give PB1/PB2)	At low setting (3)	0.15 bar (2.18 psi)
	At high setting (3)	0.19 bar (2.76 psi)
Maximum permissible pressure	Per cycle	5 bar (72.5 psi)
	Accidental	9 bar (130.5 psi)
Destruction pressure		18 bar (261 psi)
Mechanical life		8 x 10 ⁶ operating cycles
Cable entry for terminal models		1 entry tapped M20 x 1.5 mm for ISO cable gland, clamping capacity 7 to 13 mm
Pressure switch type		Diaphragm

(1) For 1 entry tapped for no. 13 cable gland, replace **S12** with **S11** (for example, **XMLD004B1S12** becomes **XMLD004B1S11**).

(2) For component materials of units in contact with the fluid, see pages 72 and 73.

(3) Deviation of the differential at low and high setting points for switches of the same size: ± 0.03 bar (± 0.43 psi).

Operating curves

High setting tripping points of contacts 1 and 2

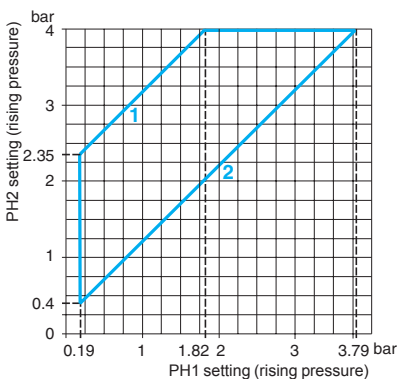

- 1 Maximum differential
- 2 Minimum differential

Natural differential of contacts 1 and 2

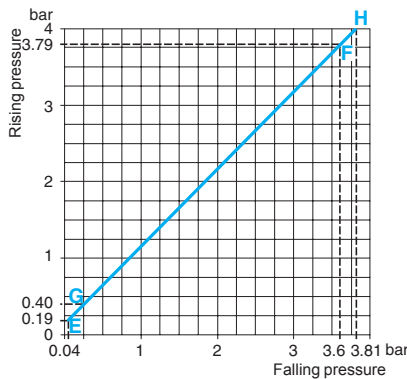

- EF Contact 1 (stage 1)
- GH Contact 2 (stage 2)

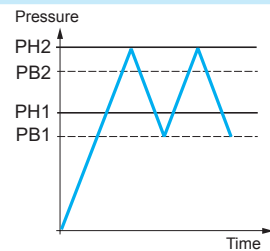

— Adjustable value
--- Non adjustable value

Connection

Terminal model

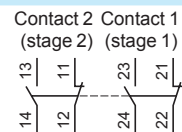

Other versions

For pressure switches with alternative tapped cable entries, such as NPT, etc. please consult our Customer Care Centre.

Electromechanical pressure switches

OsiSense XML

Size 10 bar (145 psi)

Fixed differential, for detection of a single threshold

Switches with 1 CO single-pole contact

OsiSense XMLA pressure switches

With setting scale

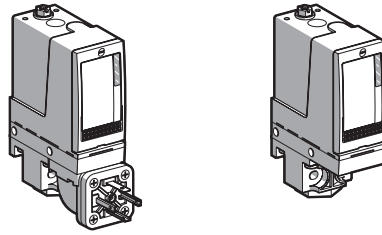

Adjustable range of switching point (PH) (Rising pressure)	0.6...10 bar (8.7...145 psi)		
Electrical connection	DIN connector	Terminals	Terminals
Fluid connection	G 1/4 (female)	G 1/4 (female)	1/4"-18 NPTF (female)

References (1)

Fluids controlled (2)		XMLA010A2C11	XMLA010A2S12	XMLA010A2S13
Hydraulic oils, fresh water, air, up to + 70 °C				
Hydraulic oils, fresh water, air, up to + 160 °C		XMLA010B2C11	XMLA010B2S12	—
Corrosive fluids, up to + 160 °C Sea water, up to + 30 °C		XMLA010C2C11	XMLA010C2S12	XMLA010C2S13
Viscous products, up to + 160 °C (G 1/4" fluid connection)		XMLA010P2C11	XMLA010P2S12	—
Weight (kg)		0.715	0.685	0.685

Complementary characteristics not shown under general characteristics (page 17)

Natural differential (subtract from PH to give PB)	At low setting (3)	0.5 bar (7.25 psi)	
	At high setting (3)	0.5 bar (7.25 psi)	
Maximum permissible pressure	Per cycle	12.5 bar (181.25 psi)	
	Accidental	22.5 bar (326.25 psi)	
Destruction pressure		45 bar (652.5 psi)	
Mechanical life		5 x 10 ⁶ operating cycles	
Connection		EN 175301-803-A (ex-DIN 43650A), 4-pin male connector. For suitable female connector, see page 68	1 entry tapped M20 x 1.5 mm for ISO cable gland, clamping capacity 7 to 13 mm
			1 entry tapped 1/2"-14 NPT for cable gland, clamping capacity 7 to 13 mm
Pressure switch type		Diaphragm	

(1) For 1 entry tapped for no. 13 cable gland, replace S12 with S11 (for example, XMLA010A2S12 becomes XMLA010A2S11).

(2) For component materials of units in contact with the fluid, see pages 72 and 73.

(3) Deviation of the differential at low and high setting points for switches of the same size: ± 0.05 bar (± 0.72 psi)

Operating curves

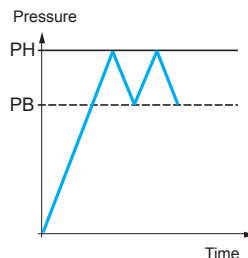
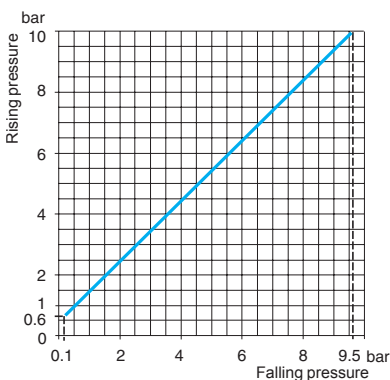

Connection

Terminal model



Connector model

Pressure switch connector pin view

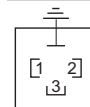

1 → 11 and 13
2 → 12
3 → 14

— Adjustable value
--- Non adjustable value

Other versions

For pressure switches with alternative tapped cable entries, such as NPT, etc. please consult our Customer Care Centre.

Electromechanical pressure switches

OsiSense XML

Size 10 bar (145 psi)

Adjustable differential, for regulation between 2 thresholds

Switches with 1 CO single-pole contact

OsiSense XMLB pressure switches	With setting scale	30 bar (435 psi) overpressure With setting scale
---------------------------------	--------------------	--

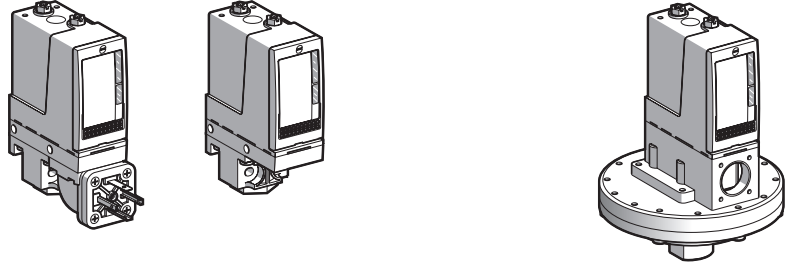

Adjustable range of switching point (PH) (Rising pressure)	0.7...10 bar (10.15...145 psi)			
Electrical connection	DIN connector	Terminals	Terminals	Terminals
Fluid connection	G 1/4 (female)	G 1/4 (female)	1/4"-18 NPTF (female)	G 1/4 (female)

References (1)					
Fluids controlled (2)	Hydraulic oils, fresh water, air, up to + 70 °C	XMLB010A2C11	XMLB010A2S12	XMLB010A2S13	XMLBS10A2S12
	Hydraulic oils, fresh water, air, up to + 160 °C	XMLB010B2C11	XMLB010B2S12	XMLB010B2S13	—
	Corrosive fluids, up to + 160 °C Sea water, up to + 30 °C	XMLB010C2C11	XMLB010C2S12	XMLB010C2S13	—
	Viscous products, up to + 160 °C (G 1/4" fluid connection)	XMLB010P2C11	XMLB010P2S12	—	—
Weight (kg)		0.735	0.705	0.705	3.500

Complementary characteristics not shown under general characteristics (page 17)					
Possible differential (subtract from PH to give PB)	Min. at low setting (3)	0.57 bar (8.26 psi)			0.45 bar (6.52 psi)
	Min. at high setting (4)	0.85 bar (12.32 psi)			0.85 bar (12.32 psi)
	Max. at high setting	7.5 bar (108.75 psi)			6.25 bar (90.62 psi)
Maximum permissible pressure	Per cycle	12.5 bar (181.25 psi)			30 bar (435 psi)
	Accidental	22.5 bar (326.25 psi)			37.5 bar (543.75 psi)
Destruction pressure		45 bar (652.5 psi)			67.5 bar (978.75 psi)
Mechanical life		5 x 10 ⁶ operating cycles			2 x 10 ⁶ operating cycles
Connection		EN 175301-803-A (ex-DIN 43650A), 4-pin male connector. For suitable female connector, see page 68	1 entry tapped M20 x 1.5 mm for ISO cable gland, clamping capacity 7 to 13 mm	1 entry tapped 1/2"-14 NPT for cable gland, clamping capacity 7 to 13 mm	1 entry tapped M20 x 1.5 mm for ISO cable gland, clamping capacity 7 to 13 mm
	Pressure switch type	Diaphragm			

(1) For 1 entry tapped for no. 13 cable gland, replace S12 with S11 (for example, XMLB010A2S12 becomes XMLB010A2S11).

(2) For component materials of units in contact with the fluid, see pages 72 and 73.

(3) Deviation of the differential at low setting point for switches of the same size:
± 0.05 bar (± 0.72 psi).

(4) Deviation of the differential at high setting point for switches of the same size:
- 0.1 bar, + 0.15 bar (- 1.45 psi, + 2.17 psi).

Operating curves

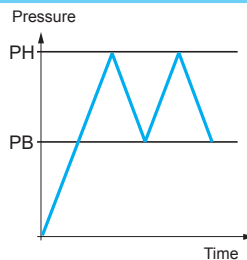
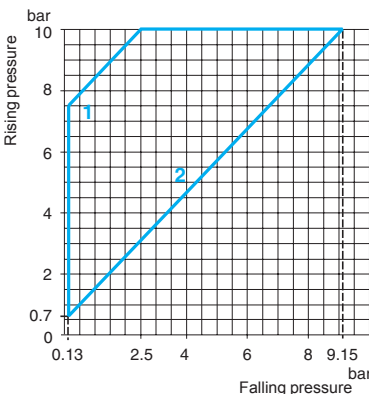

Connection

Terminal model



Connector model

Pressure switch connector pin view

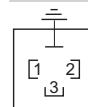

- 1 → 11 and 13
- 2 → 12
- 3 → 14

- 1 Maximum differential
- 2 Minimum differential

— Adjustable value

Electromechanical pressure switches

OsiSense XML

Size 10 bar (145 psi)

Adjustable differential, for regulation between 2 thresholds

Switches with 2 CO single-pole contacts

OsiSense XMLC pressure switches	With setting scale	30 bar (435 psi) overpressure With setting scale
---------------------------------	--------------------	---

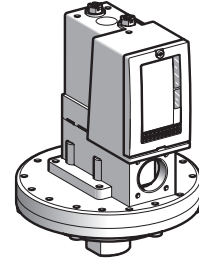
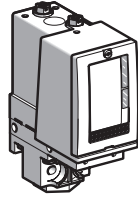

Adjustable range of switching point (PH) (Rising pressure)	0.7...10 bar (10.15...145 psi)		
Electrical connection	Terminals		
Fluid connection	G 1/4 (female)	1/4"-18 NPTF (female)	G 1/4 (female)

References (1)

Fluids controlled (2)	Hydraulic oils, fresh water, air, up to + 70 °C	—	—	XMLCS10A2S12
	Hydraulic oils, fresh water, air, up to + 160 °C	XMLC010B2S12	XMLC010B2S13	—
	Corrosive fluids, up to + 160 °C Sea water, up to + 30 °C	XMLC010C2S12	XMLC010C2S13	—
Weight (kg)	0.685	0.685	3.500	

Complementary characteristics not shown under general characteristics (page 17)

Possible differential (subtract from PH to give PB)	Min. at low setting (3)	0.45 bar (6.53 psi)	0.25 bar (3.62 psi)	
	Min. at high setting (4)	0.70 bar (10.15 psi)	0.65 bar (9.42 psi)	
	Max. at high setting	8 bar (116 psi)	5.6 bar (81.2 psi)	
Maximum permissible pressure	Per cycle	12.5 bar (181.25 psi)	30 bar (435 psi)	
	Accidental	22.5 bar (326.25 psi)	37.5 bar (543.75 psi)	
Destruction pressure		45 bar (652.5 psi)	67.5 bar (978.75 psi)	
Mechanical life		5 x 10 ⁶ operating cycles	2 x 10 ⁶ operating cycles	
Cable entry for terminal models		1 entry tapped M20 x 1.5 mm for ISO cable gland, clamping capacity 7 to 13 mm	1 entry tapped 1/2"-14 NPT for cable gland, clamping capacity 7 to 13 mm	1 entry tapped M20 x 1.5 mm for ISO cable gland, clamping capacity 7 to 13 mm
Pressure switch type	Diaphragm			

(1) For 1 entry tapped for no. 13 cable gland, replace S12 with S11 (for example, XMLC010B2S12 becomes XMLC010B2S11).

(2) For component materials of units in contact with the fluid, see pages 72 and 73.

(3) Deviation of the differential at low setting point for switches of the same size:
± 0.05 bar (± 0.72 psi)

(4) Deviation of the differential at high setting point for switches of the same size:
± 0.01 bar (± 1.45 psi)

Operating curves

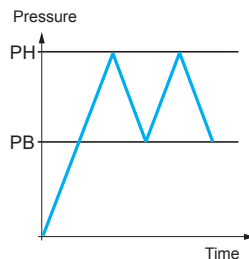
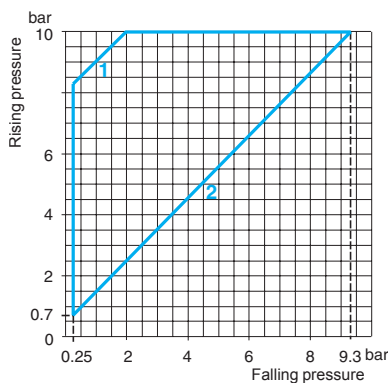

Connection

Terminal model

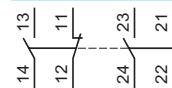

- 1 Maximum differential
- 2 Minimum differential

— Adjustable value

Other versions

For pressure switches with alternative tapped cable entries, such as NPT, etc. please consult our Customer Care Centre.

OsiSense XMLD pressure switches

Without setting scale

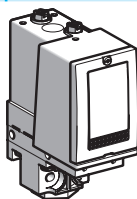

Adjustable range of each switching point (Rising pressure)	2nd stage switching point (PH2) 1st stage switching point (PH1)	1.2...10 bar (17.4...145 psi) 0.52...9.32 bar (7.54...135.14 psi)
Spread between 2 stages (PH2 - PH1)		0.68...5.8 bar (9.86...84.1 psi)
Fluid connection		G 1/4 (female)
Electrical connection		Terminals

References

Fluids controlled (1)	Hydraulic oils, fresh water, air, up to + 160 °C	XMLD010B1S11	XMLD010B1S12
	Corrosive fluids, up to + 160 °C Sea water, up to + 30 °C	XMLD010C1S11	–
Weight (kg)		0.705	0.705

Complementary characteristics not shown under general characteristics (page 17)

Natural differential (subtract from PH1/PH2 to give PB1/PB2)	At low setting (2)	0.45 bar (6.53 psi)
	At high setting (3)	0.6 bar (8.7 psi)
Maximum permissible pressure	Per cycle	12.5 bar (181.25 psi)
	Accidental	22.5 bar (326.25 psi)
Destruction pressure		45 bar (652.5 psi)
Mechanical life		5 x 10 ⁹ operating cycles
Cable entry for terminal models	1 entry tapped for no. 13 cable gland	1 entry tapped M20 x 1.5 mm for ISO cable gland, clamping capacity 7 to 13 mm
Pressure switch type		Diaphragm

(1) For component materials of units in contact with the fluid, see pages 72 and 73.

(2) Deviation of the differential at low setting point for switches of the same size:
± 0.05 bar (± 0.72 psi)

(3) Deviation of the differential at high setting point for switches of the same size:
± 0.1 bar (± 1.45 psi)

Operating curves

High setting tripping points of contacts 1 and 2

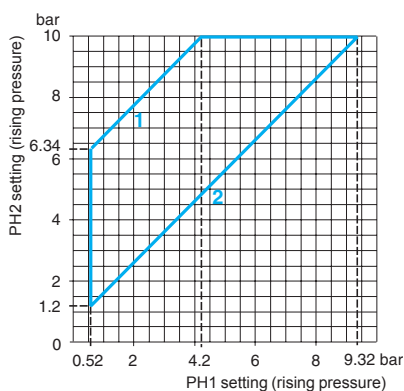

- 1 Maximum differential
- 2 Minimum differential

Natural differential of contacts 1 and 2

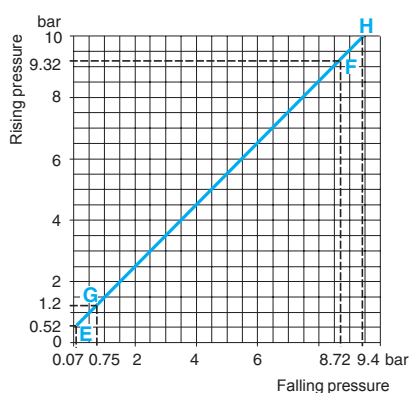

- EF Contact 1 (stage 1)
- GH Contact 2 (stage 2)

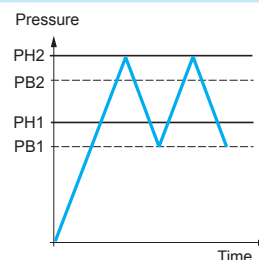

— Adjustable value
--- Non adjustable value

Connection

Terminal model

Contact 2 (stage 2) | Contact 1 (stage 1)

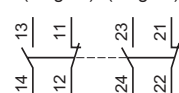

Other versions

For pressure switches with alternative tapped cable entries, such as NPT, etc. please consult our Customer Care Centre.

Electromechanical pressure switches

OsiSense XML

Size 20 bar (290 psi)

Fixed differential, for detection of a single threshold

Switches with 1 CO single-pole contact

OsiSense XMLA pressure switches

With setting scale

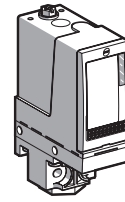
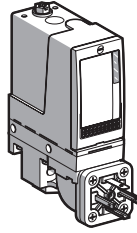

Adjustable range of switching point (PH) (Rising pressure)	1...20 bar (14.5...290 psi)		
Electrical connection	DIN connector	Terminals	
Fluid connection	G 1/4 (female)	G 1/4 (female)	1/4"-18 NPTF (female)

References (1)

Fluids controlled (2)	Hydraulic oils, fresh water, air, up to + 70 °C	XMLA020A2C11	XMLA020A2S12	XMLA020A2S13
	Hydraulic oils, fresh water, air, up to + 160 °C	XMLA020B2C11	XMLA020B2S12	—
	Corrosive fluids, up to + 160 °C Sea water, up to + 30 °C	XMLA020C2C11	XMLA020C2S12	—
	Viscous products, up to + 160 °C (G 1/4" fluid connection)	XMLA020P2C11	XMLA020P2S12	—
Weight (kg)		0.715	0.685	0.685

Complementary characteristics not shown under general characteristics (page 17)

Natural differential (subtract from PH to give PB)	At low setting (3)	0.4 bar (5.8 psi)		
	At high setting (3)	1 bar (14.5 psi)		
Maximum permissible pressure	Per cycle	25 bar (362.5 psi)		
	Accidental	45 bar (652.5 psi)		
Destruction pressure		90 bar (1305 psi)		
Mechanical life		5 x 10 ⁶ operating cycles		
Connection		EN 175301-803-A (ex-DIN 43650A), 4-pin male connector. For suitable female connector, see page 68	1 entry tapped M20 x 1.5 mm for ISO cable gland, clamping capacity 7 to 13 mm	1 entry tapped 1/2"-14 NPT for cable gland, clamping capacity 7 to 13 mm
	Pressure switch type	Diaphragm		

(1) For 1 entry tapped for no. 13 cable gland, replace S12 with S11 (for example, XMLA020A2S12 becomes XMLA020A2S11).

(2) For component materials of units in contact with the fluid, see pages 72 and 73.

(3) Deviation of the differential at high setting point for switches of the same size:
± 0.1 bar (± 1.45 psi)

Deviation of the differential at low setting point: ± 0.2 bar (± 2.9 psi)

Operating curves

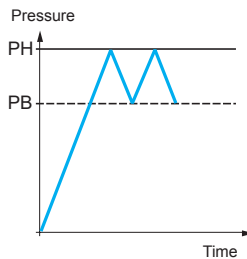
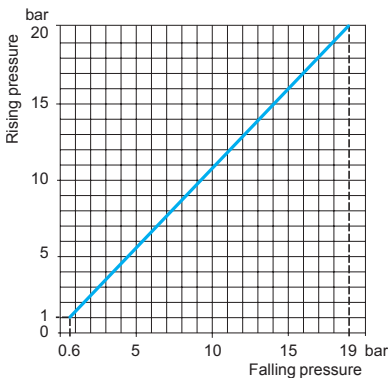

Connection

Terminal model



Connector model

Pressure switch connector pin view

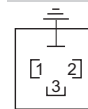

1 → 11 and 13
2 → 12
3 → 14

— Adjustable value
--- Non adjustable value

Other versions

For pressure switches with alternative tapped cable entries, such as NPT, etc. please consult our Customer Care Centre.

Electromechanical pressure switches

OsiSense XML

Size 20 bar (290 psi)

Adjustable differential, for regulation between 2 thresholds

Switches with 1 CO single-pole contact

OsiSense XMLB pressure switches	With setting scale	30 bar (435 psi) overpressure With setting scale
---------------------------------	--------------------	--

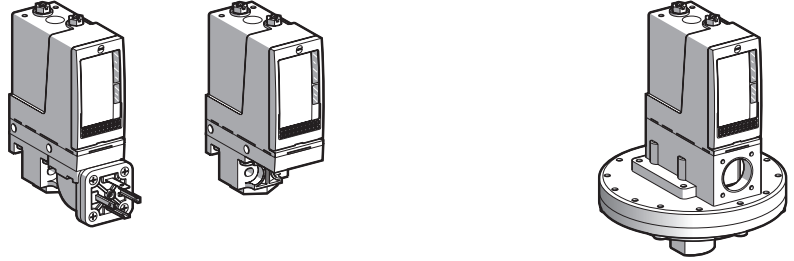

Adjustable range of switching point (PH) (Rising pressure)	1.3...20 bar (18.9...290 psi)			
Electrical connection	DIN connector	Terminals		
Fluid connection	G 1/4 (female)	G 1/4 (female)	1/4"-18 NPTF (female)	G 1/4 (female)

References (1)					
Fluids controlled (2)	Hydraulic oils, fresh water, air, up to + 70 °C	XMLB020A2C11	XMLB020A2S12	XMLB020A2S13	XMLBS20A2S12
	Hydraulic oils, fresh water, air, up to + 160 °C	XMLB020B2C11	XMLB020B2S12	XMLB020B2S13	—
	Corrosive fluids, up to + 160 °C Sea water, up to + 30 °C	XMLB020C2C11	XMLB020C2S12	—	—
	Viscous products, up to + 160 °C (G 1/4" fluid connection)	XMLB020P2C11	XMLB020P2S12	—	—
Weight (kg)		0.735	0.705	0.705	3.500

Complementary characteristics not shown under general characteristics (page 17)					
Possible differential (subtract from PH to give PB)	Min. at low setting (3)	1 bar (14.5 psi)			0.95 bar (13.78 psi)
	Min. at high setting (3)	1.6 bar (23.20 psi)			1.45 bar (21.03 psi)
	Max. at high setting	11 bar (159.5 psi)			12.6 bar (182.7 psi)
Maximum permissible pressure	Per cycle	25 bar (362.5 psi)			30 bar (435 psi)
	Accidental	45 bar (652.5 psi)			37.5 bar (543.75 psi)
Destruction pressure		90 bar (1305 psi)			67.5 bar (978.75 psi)
Mechanical life		5 x 10 ⁶ operating cycles			2 x 10 ⁶ operating cycles
Connection		EN 175301-803-A (ex-DIN 43650A), 4-pin male connector. For suitable female connector, see page 68	1 entry tapped M20 x 1.5 mm for ISO cable gland, clamping capacity 7 to 13 mm	1 entry tapped 1/2"-14 NPT for cable gland, clamping capacity 7 to 13 mm	1 entry tapped M20 x 1.5 mm for ISO cable gland, clamping capacity 7 to 13 mm
Pressure switch type		Diaphragm			

(1) For 1 entry tapped for no. 13 cable gland, replace S12 with S11 (for example, XMLB020A2S12 becomes XMLB020A2S11).

(2) For component materials of units in contact with the fluid, see pages 72 and 73.

(3) Deviation of the differential at low and high setting points for switches of the same size:
± 0.25 bar (± 3.63 psi)

Operating curves

1 Maximum differential
2 Minimum differential

Connection

Terminal model

Connector model
Pressure switch connector pin view

1 → 11 and 13
2 → 12
3 → 14

— Adjustable value

Other versions For pressure switches with alternative tapped cable entries, such as NPT, etc. please consult our Customer Care Centre.

Electromechanical pressure switches

OsiSense XML

Size 20 bar (290 psi)

Adjustable differential, for regulation between 2 thresholds

Switches with 2 CO single-pole contacts

OsiSense XMLC pressure switches	With setting scale	30 bar (435 psi) overpressure With setting scale
---------------------------------	--------------------	---

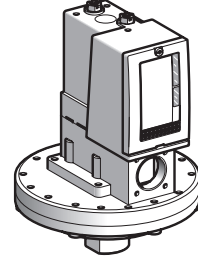
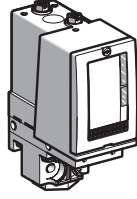

Adjustable range of switching point (PH) (Rising pressure)	1.3...20 bar (18.85...290 psi)		
Electrical connection	Terminals		
Fluid connection	G 1/4 (female)	1/4"-18 NPTF (female)	G 1/4 (female)

References (1)

Fluids controlled (2)	Hydraulic oils, fresh water, air, up to + 70 °C	—	—	XMLCS20A2S12
	Hydraulic oils, fresh water, air, up to + 160 °C	XMLC020B2S12	XMLC020B2S13	—
	Corrosive fluids, up to + 160 °C Sea water, up to + 30 °C	XMLC020C2S12	XMLC020C2S13	—
Weight (kg)	0.685	0.685	3.500	

Complementary characteristics not shown under general characteristics (page 17)

Possible differential (subtract from PH to give PB)	Min. at low setting (3)	0.7 bar (10.15 psi)	0.7 bar (10.15 psi)	
	Min. at high setting (3)	1 bar (14.5 psi)	1.15 bar (16.67 psi)	
	Max. at high setting	11 bar (159.5 psi)	11.70 bar (169.6 psi)	
Maximum permissible pressure	Per cycle	25 bar (362.5 psi)	30 bar (435 psi)	
	Accidental	45 bar (652.5 psi)	37.5 bar (543.75 psi)	
Destruction pressure		90 bar (1305 psi)	67.5 bar (978.75 psi)	
Mechanical life		5 x 10 ⁶ operating cycles	2 x 10 ⁶ operating cycles	
Cable entry for terminal models		1 entry tapped M20 x 1.5 mm for ISO cable gland, clamping capacity 7 to 13 mm	1 entry tapped 1/2"-14 NPT for cable gland, clamping capacity 7 to 13 mm	1 entry tapped M20 x 1.5 mm for ISO cable gland, clamping capacity 7 to 13 mm
Pressure switch type		Diaphragm		

(1) For 1 entry tapped for no. 13 cable gland, replace S12 with S11 (for example, XMLC020B2S12 becomes XMLC020B2S11).

(2) For component materials of units in contact with the fluid, see pages 72 and 73.

(3) Deviation of the differential at low and high setting points for switches of the same size: ± 0.2 bar (± 2.9 psi)

Operating curves

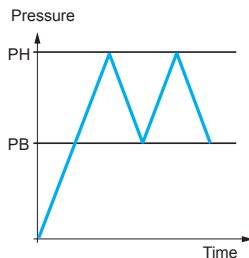
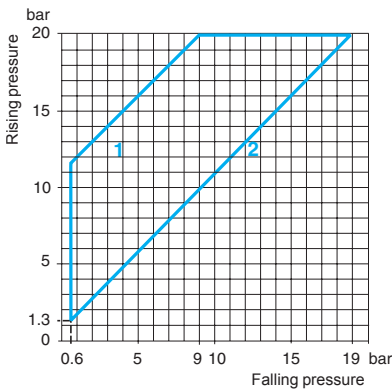

Connection

Terminal model

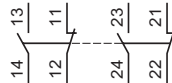

- 1 Maximum differential
- 2 Minimum differential

— Adjustable value

Other versions For pressure switches with alternative tapped cable entries, such as NPT, etc. please consult our Customer Care Centre.

Electromechanical pressure switches

OsiSense XML

Size 20 bar (290 psi)

Dual stage, fixed differential, for detection at each threshold

Switches with 2 CO single-pole contacts

OsiSense XMLD pressure switches

Without setting scale

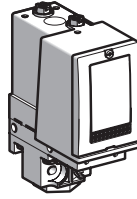

Adjustable range of each switching point (Rising pressure)	2nd stage switching point (PH2) 1st stage switching point (PH1)	2.14...20 bar (31.03...290 psi) 0.9...18.76 bar (13.05...272.02 psi)
Spread between 2 stages (PH2 - PH1)		1.24...9.55 bar (17.98...138.48 psi)
Electrical connection	Terminals	
Fluid connection	G 1/4 (female)	1/4"-18 NPTF (female)

References (1)

Fluids controlled (2)	Hydraulic oils, fresh water, air, up to + 160 °C Corrosive fluids, up to + 160 °C Sea water, up to + 30 °C	XMLD020B1S12 XMLD020C1S12	XMLD020B1S13 -
Weight (kg)		0.705	0.705

Complementary characteristics not shown under general characteristics (page 17)

Natural differential (subtract from PH1/PH2 to give PB1/PB2)	At low setting (3) At high setting (4)	0.7 bar (10.15 psi) 1.3 bar (18.85 psi)
Maximum permissible pressure	Per cycle Accidental	25 bar (362.5 psi) 45 bar (652.5 psi)
Destruction pressure		90 bar (1305 psi)
Mechanical life		5 x 10 ⁶ operating cycles
Cable entry for terminal models	1 entry tapped M20 x 1.5 mm for ISO cable gland, clamping capacity 7 to 13 mm	1 entry tapped 1/2"-14 NPT for cable gland, clamping capacity 7 to 13 mm
Pressure switch type	Diaphragm	

(1) For 1 entry tapped for no. 13 cable gland, replace **S12** with **S11** (for example, **XMLD020B1S12** becomes **XMLD020B1S11**).

(2) For component materials of units in contact with the fluid, see pages 72 and 73.

(3) Deviation of the differential at low setting point for switches of the same size:
± 0.15 bar (± 2.18 psi)

(4) Deviation of the differential at high setting point for switches of the same size:
± 0.3 bar (± 4.35 psi)

Operating curves

High setting tripping points of contacts 1 and 2

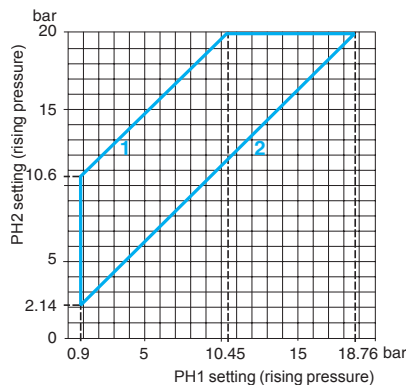

- 1 Maximum differential
- 2 Minimum differential

Natural differential of contacts 1 and 2

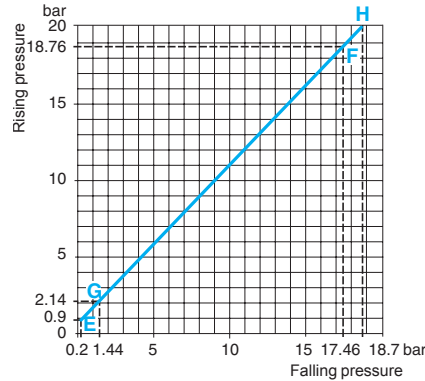

- EF Contact 1 (stage 1)
- GH Contact 2 (stage 2)

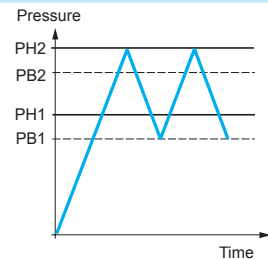

— Adjustable value
--- Non adjustable value

Connection model

Terminal model

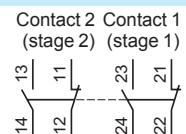

Other versions

For pressure switches with alternative tapped cable entries, such as NPT, etc. please consult our Customer Care Centre.

Electromechanical pressure switches

OsiSense XML

Size 35 bar (507.5 psi)

Fixed differential, for detection of a single threshold

Switches with 1 CO single-pole contact

OsiSense XMLA pressure switches

With setting scale

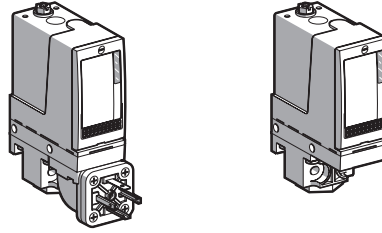

Adjustable range of switching point (PH) (Rising pressure)	1.5...35 bar (21.75...507.5 psi)		
Electrical connection	DIN connector	Terminals	
Fluid connection	G 1/4 (female)	G 1/4 (female)	1/4"-18 NPTF (female)

References (1)

Fluids controlled (2)	Hydraulic oils, fresh water, air, up to + 70 °C	XMLA035A2C11	XMLA035A2S12	XMLA035A2S13
	Hydraulic oils, fresh water, air, up to + 160 °C	XMLA035B2C11	XMLA035B2S12	—
	Corrosive fluids, up to + 160 °C Sea water, up to + 30 °C	XMLA035C2C11	XMLA035C2S12	—
	Viscous products, up to + 160 °C (G 1/4" fluid connection)	XMLA035P2C11	XMLA035P2S12	—
Weight (kg)		0.725	0.695	0.695

Complementary characteristics not shown under general characteristics (page 17)

Natural differential (subtract from PH to give PB)	At low setting (3)	1.25 bar (18.12 psi)	
	At high setting (3)	1.25 bar (18.12 psi)	
Maximum permissible pressure	Per cycle	45 bar (652.5 psi)	
	Accidental	80 bar (1160 psi)	
Destruction pressure		160 bar (2320 psi)	
Mechanical life		5 x 10 ⁶ operating cycles	
Connection	EN 175301-803-A (ex-DIN 43650A), 4-pin male connector. For suitable female connector, see page 68	1 entry tapped M20 x 1.5 mm for ISO cable gland, clamping capacity 7 to 13 mm	1 entry tapped 1/2"-14 NPT for cable gland, clamping capacity 7 to 13 mm
	Pressure switch type	Diaphragm	

(1) For 1 entry tapped for no. 13 cable gland, replace S12 with S11 (for example, XMLA035A2S12 becomes XMLA035A2S11).

(2) For component materials of units in contact with the fluid, see pages 72 and 73.

(3) Deviation of the differential at low and high setting points for switches of the same size:
± 0.25 bar (± 3.62 psi)

Operating curves

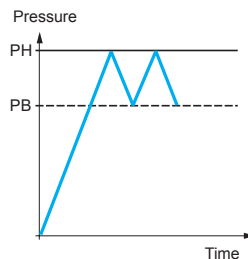
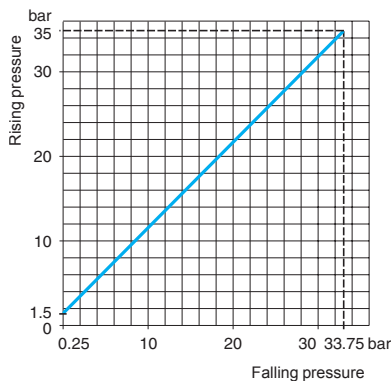

Connection

Terminal model



Connector model

Pressure switch connector pin view

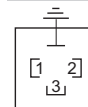

1 → 11 and 13
2 → 12
3 → 14

— Adjustable value
--- Non adjustable value

Other versions

For pressure switches with alternative tapped cable entries, such as NPT, etc. please consult our Customer Care Centre.

OsiSense XMLB pressure switches

With setting scale

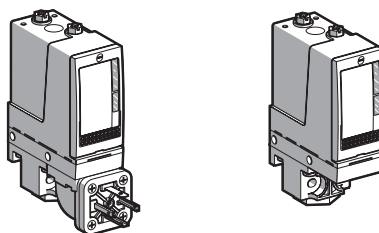

Adjustable range of switching point (PH) (Rising pressure)	3.5...35 bar (50.75...507.5 psi)		
Electrical connection	DIN connector	Terminals	
Fluid connection	G 1/4 (female)	G 1/4 (female)	1/4"-18 NPTF (female)

References (1)

Fluids controlled (2)	Hydraulic oils, fresh water, air, up to + 70 °C	XMLB035A2C11	XMLB035A2S12	XMLB035A2S13
	Hydraulic oils, fresh water, air, up to + 160 °C	XMLB035B2C11	XMLB035B2S12	—
	Corrosive fluids, up to + 160 °C Sea water, up to + 30 °C	XMLB035C2C11	XMLB035C2S12	—
	Viscous products, up to + 160 °C (G 1/4" fluid connection)	—	XMLB035P2S12	—
Weight (kg)		0.745	0.715	0.715

Complementary characteristics not shown under general characteristics (page 17)

Possible differential (subtract from PH to give PB)	Min. at low setting (3)	1.7 bar (24.65 psi)		
	Min. at high setting (3)	2.55 bar (36.97 psi)		
	Max. at high setting	20 bar (290 psi)		
Maximum permissible pressure	Per cycle	45 bar (652.5 psi)		
	Accidental	80 bar (1160 psi)		
Destruction pressure		160 bar (2320 psi)		
Mechanical life		5 x 10 ⁶ operating cycles		
Connection		EN 175301-803-A connector (ex-DIN 43650A), 4-pin male. For suitable female connector, see page 68	1 entry tapped M20 x 1.5 mm for ISO cable gland, clamping capacity 7 to 13 mm	1 entry tapped 1/2"-14 NPT for cable gland, clamping capacity 7 to 13 mm
Pressure switch type		Diaphragm		

(1) For 1 entry tapped for no. 13 cable gland, replace **S12** with **S11** (for example, **XMLB035A2S12** becomes **XMLB035A2S11**).

(2) For component materials of units in contact with the fluid, see pages 72 and 73.

(3) Deviation of the differential at low and high setting points for switches of the same size:
- 0.5 bar, + 0.7 bar (- 7.25 psi, + 10.15 psi).

Operating curves

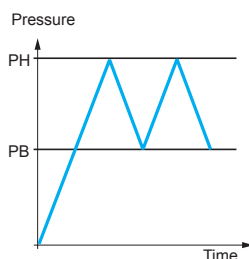
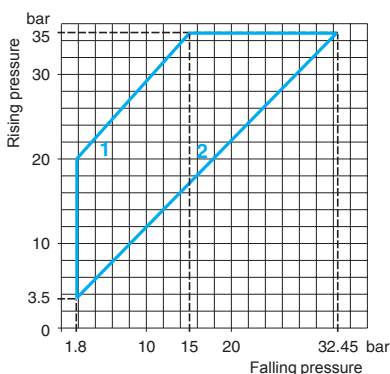

Connection

Terminal model



Connector model

Pressure switch connector pin view

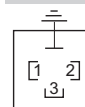

1 → 11 and 13
2 → 12
3 → 14

- 1 Maximum differential
- 2 Minimum differential

— Adjustable value

Other versions

For pressure switches with alternative tapped cable entries, such as NPT, etc. please consult our Customer Care Centre.

Electromechanical pressure switches

OsiSense XML

Size 35 bar (507.5 psi)

Adjustable differential, for regulation between 2 thresholds

Switches with 2 CO single-pole contacts

OsiSense XMLC pressure switches

With setting scale

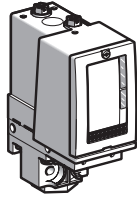

Adjustable range of switching point (PH) (Rising pressure)	3.5...35 bar (50.75...507.5 psi)	
Electrical connection	Terminals	
Fluid connection	G 1/4 (female)	1/4"-18 NPTF (female)

References (1)

Fluids controlled (2)	Hydraulic oils, fresh water, air, up to + 160 °C	XMLC035B2S12	XMLC035B2S13
	Corrosive fluids, up to + 160 °C Sea water, up to + 30 °C	XMLC035C2S12	XMLC035C2S13
Weight (kg)	0.695		0.695

Complementary characteristics not shown under general characteristics (page 17)

Possible differential (subtract from PH to give PB)	Min. at low setting (3)	1 bar (14.5 psi)	
	Min. at high setting (4)	1.5 bar (21.75 psi)	
	Max. at high setting	22 bar (319 psi)	
Maximum permissible pressure	Per cycle	45 bar (652.5 psi)	
	Accidental	80 bar (1160 psi)	
Destruction pressure	160 bar (2320 psi)		
Mechanical life	5 x 10 ⁸ operating cycles		
Cable entry for terminal models	1 entry tapped M20 x 1.5 mm for ISO cable gland, clamping capacity 7 to 13 mm		1 entry tapped 1/2"-14 NPT for cable gland, clamping capacity 7 to 13 mm
Pressure switch type	Diaphragm		

(1) For 1 entry tapped for no. 13 cable gland, replace S12 with S11 (for example, XMLC035B2S12 becomes XMLC035B2S11).

(2) For component materials of units in contact with the fluid, see pages 72 and 73.

(3) Deviation of the differential at low setting point for switches of the same size:
± 0.2 bar (± 2.9 psi)

(4) Deviation of the differential at high setting point for switches of the same size:
± 0.5 bar (± 7.25 psi)

Operating curves

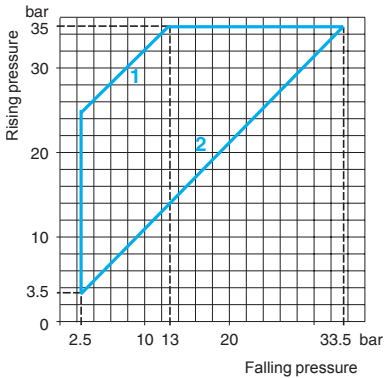

- 1 Maximum differential
- 2 Minimum differential

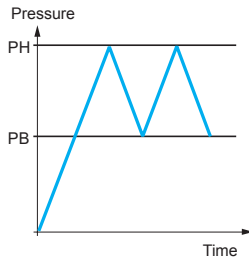

— Adjustable value

Other versions

For pressure switches with alternative tapped cable entries, such as NPT, etc. please consult our Customer Care Centre.

Connection

Terminal model

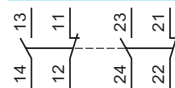

OsiSense XMLD pressure switches

Without setting scale

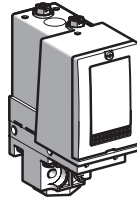

Adjustable range of each switching point (Rising pressure)	2nd stage switching point (PH2) 1st stage switching point (PH1)	4.4...35 bar (63.8...507.5 psi) 1.9...32.5 bar (27.55...471.25 psi)
Spread between 2 stages (PH2 - PH1)		2.5...20.4 bar (36.25...295.8 psi)
Electrical connection		Terminals
Fluid connection		G 1/4 (female)

References (1)

Fluids controlled (2)	Hydraulic oils, fresh water, air, up to + 160 °C	XMLD035B1S12
Weight (kg)		0.715

Complementary characteristics not shown under general characteristics (page 17)

Natural differential (subtract from PH1/PH2 to give PB1/PB2)	At low setting (3) At high setting (4)	1.5 bar (21.75 psi) 2.6 bar (37.7 psi)
Maximum permissible pressure	Per cycle Accidental	45 bar (652.5 psi) 80 bar (1160 psi)
Destruction pressure		160 bar (2320 psi)
Mechanical life		5 x 10 ⁶ operating cycles
Cable entry for terminal models		1 entry tapped M20 x 1.5 mm for ISO cable gland, clamping capacity 7 to 13 mm
Pressure switch type		Diaphragm

(1) For 1 entry tapped for no. 13 cable gland, replace S12 with S11 (for example, XMLD035B1S12 becomes XMLD035B1S11).

(2) For component materials of units in contact with the fluid, see pages 72 and 73.

(3) Deviation of the differential at low setting point for switches of the same size:
± 0.3 bar (± 4.35 psi)

(4) Deviation of the differential at high setting point for switches of the same size:
± 0.7 bar (± 10.15 psi)

Operating curves

High setting tripping points of contacts 1 and 2

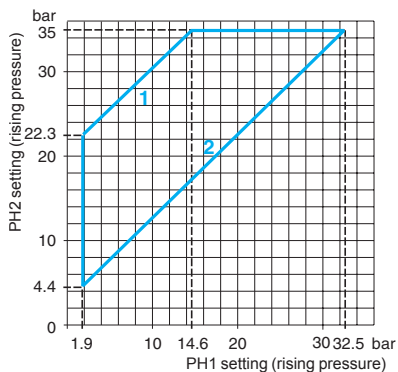

- 1 Maximum differential
- 2 Minimum differential

Natural differential of contacts 1 and 2

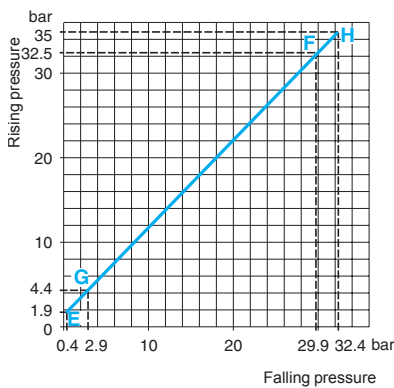

- EF Contact 1 (stage 1)
- GH Contact 2 (stage 2)

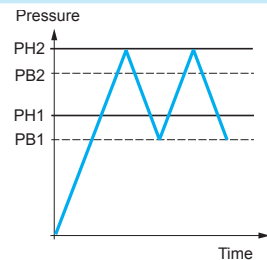

— Adjustable value
--- Non adjustable value

Connection

Terminal model

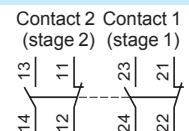

Other versions

For pressure switches with alternative tapped cable entries, such as NPT, etc. please consult our Customer Care Centre.

Electromechanical pressure switches

OsiSense XML

Size 70 bar (1015 psi)

Fixed differential, for detection of a single threshold

Switches with 1 CO single-pole contact

OsiSense XMLA pressure switches

With setting scale

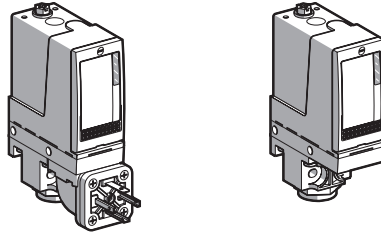

Adjustable range of switching point (PH) (Rising pressure)	5...70 bar (72.5...1015 psi)		
Electrical connection	DIN connector	Terminals	
Fluid connection	G 1/4 (female)	G 1/4 (female)	1/4"-18 NPTF (female)

References (1)

Fluids controlled (2)	Hydraulic oils, up to + 160 °C	XMLA070D2C11	XMLA070D2S12	XMLA070D2S13
	Fresh water, up to + 160 °C	XMLA070E2C11	XMLA070E2S12	XMLA070E2S13
	Corrosive fluids, air, up to + 160 °C	XMLA070N2C11	XMLA070N2S12	—
Weight (kg)		0.725	0.695	0.695

Complementary characteristics not shown under general characteristics (page 17)

Natural differential (subtract from PH to give PB)	At low setting (3)	3 bar (43.5 psi)		
	At high setting (3)	9.5 bar (137.75 psi)		
Maximum permissible pressure	Per cycle	90 bar (1035 psi)		
	Accidental	160 bar (2320 psi)		
Destruction pressure		320 bar (4640 psi)		
Mechanical life		6 x 10 ⁶ operating cycles		
Connection		EN 175301-803-A (ex-DIN 43650A), 4-pin male connector. For suitable female connector, see page 68	1 entry tapped M20 x 1.5 mm for ISO cable gland, clamping capacity 7 to 13 mm	1 entry tapped 1/2"-14 NPT for cable gland, clamping capacity 7 to 13 mm
Pressure switch type		Piston		

(1) For 1 entry tapped for no. 13 cable gland, replace S12 with S11 (for example, XMLA070D2S12 becomes XMLA070D2S11).

(2) For component materials of units in contact with the fluid, see pages 72 and 73.

(3) Deviation of the differential at low and high setting points for switches of the same size: ± 1 bar (± 14.5 psi)

Operating curves

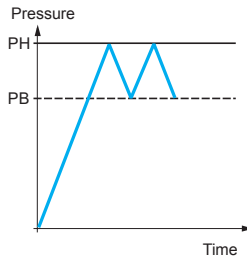
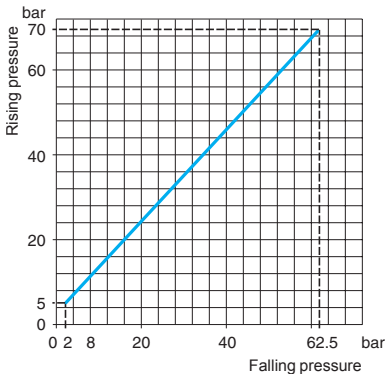

Connection

Terminal model



Connector model

Pressure switch connector pin view

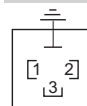

1 → 11 and 13
2 → 12
3 → 14

— Adjustable value
--- Non adjustable value

Other versions

For pressure switches with alternative tapped cable entries, such as NPT, etc. please consult our Customer Care Centre.

OsiSense XMLB pressure switches

With setting scale

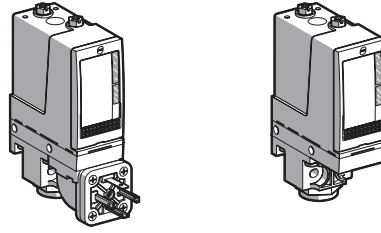

Adjustable range of switching point (PH) (Rising pressure)	7...70 bar (101.5...1015 psi)		
Electrical connection	DIN connector	Terminals	
Fluid connection	G 1/4 (female)	G 1/4 (female)	1/4"-18 NPTF (female)

References (1)

Fluids controlled (2)	Hydraulic oils, up to + 160 °C	XMLB070D2C11	XMLB070D2S12	XMLB070D2S13
	Fresh water, up to + 160 °C	XMLB070E2C11	XMLB070E2S12	—
	Corrosive fluids, air, up to + 160 °C	XMLB070N2C11	XMLB070N2S12	—
Weight (kg)		0.745	0.715	0.715

Complementary characteristics not shown under general characteristics (page 17)

Possible differential (subtract from PH to give PB)	Min. at low setting (3)	4.7 bar (68.15 psi)		
	Min. at high setting (4)	9.5 bar (137.75 psi)		
	Max. at high setting	50 bar (725 psi)		
Maximum permissible pressure	Per cycle	90 bar (1035 psi)		
	Accidental	160 bar (2320 psi)		
Destruction pressure		320 bar (4640 psi)		
Mechanical life		6 x 10 ⁸ operating cycles		
Connection		EN 175301-803-A connector (ex-DIN 43650A), 4-pin male connector. For suitable female connector, see page 68	1 entry tapped M20 x 1.5 mm for ISO cable gland, clamping capacity 7 to 13 mm	1 entry tapped 1/2"-14 NPT for cable gland, clamping capacity 7 to 13 mm
Pressure switch type		Piston		

(1) For 1 entry tapped for no. 13 cable gland, replace S12 with S11 (for example, XMLB070D2S12 becomes XMLB070D2S11).

(2) For component materials of units in contact with the fluid, see pages 72 and 73.

(3) Deviation of the differential at low setting point for switches of the same size:
- 0.4 bar, + 0.7 bar (- 5.8 psi, + 10.15 psi).

(4) Deviation of the differential at high setting point for switches of the same size:
- 0.6 bar, + 0.8 bar (- 8.7 psi, + 11.6 psi).

Operating curves

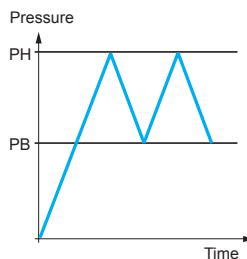
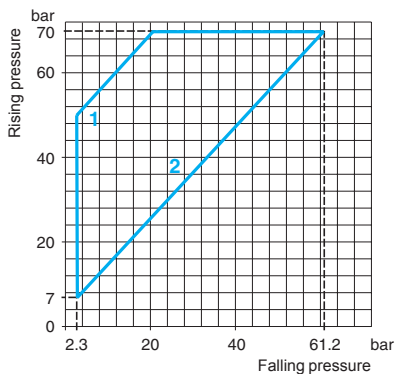

Connection

Terminal model



Connector model

Pressure switch connector pin view

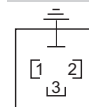

1 → 11 and 13
2 → 12
3 → 14

- 1 Maximum differential
- 2 Minimum differential

— Adjustable value

Other versions

For pressure switches with alternative tapped cable entries, such as NPT, etc. please consult our Customer Care Centre.

Electromechanical pressure switches

OsiSense XML

Size 70 bar (1015 psi)

Adjustable differential, for regulation between 2 thresholds

Switches with 2 CO single-pole contacts

OsiSense XMLC pressure switches

With setting scale

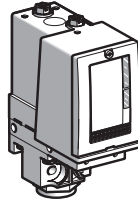

Adjustable range of switching point (PH) (Rising pressure)	7...70 bar (101.5...1015 psi)	
Electrical connection	Terminals	
Fluid connection	G 1/4 (female)	1/4"-18 NPTF (female)

References (1)

Fluids controlled (2)	Hydraulic oils, up to + 160 °C	XMLC070D2S12	XMLC070D2S13
	Fresh water, up to + 160 °C	XMLC070E2S12	-
	Corrosive fluids, air, up to + 160 °C	XMLC070N2S12	-
Weight (kg)	0.695		0.695

Complementary characteristics not shown under general characteristics (page 17)

Possible differential (subtract from PH to give PB)	Min. at low setting (3)	4.5 bar (65.25 psi)
	Min. at high setting (3)	9.5 bar (137.75 psi)
	Max. at high setting	60 bar (870 psi)
Maximum permissible pressure	Per cycle	90 bar (1035 psi)
	Accidental	160 bar (2320 psi)
Destruction pressure	320 bar (4640 psi)	
Mechanical life	6 x 10 ⁸ operating cycles	
Cable entry for terminal models	1 entry tapped M20 x 1.5 mm for ISO cable gland, clamping capacity 7 to 13 mm	1 entry tapped 1/2"-14 NPT for cable gland, clamping capacity 7 to 13 mm
Pressure switch type	Piston	

(1) For 1 entry tapped for no. 13 cable gland, replace S12 with S11 (for example, XMLC070D2S12 becomes XMLC070D2S11).

(2) For component materials of units in contact with the fluid, see pages 72 and 73.

(3) Deviation of the differential at low and high setting points for switches of the same size: ± 0.8 bar (± 11.6 psi)

Operating curves

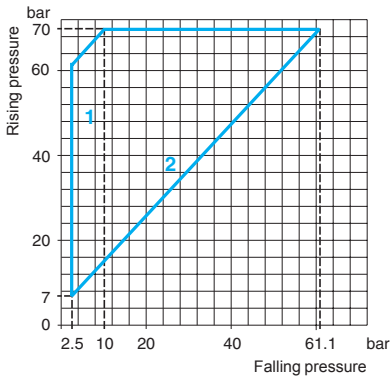

- 1 Maximum differential
- 2 Minimum differential

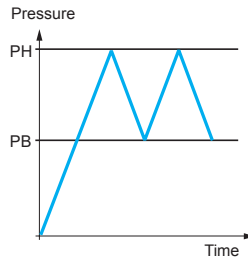

— Adjustable value

Connection

Terminal model

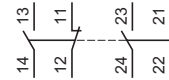

Other versions

For pressure switches with alternative tapped cable entries, such as NPT, etc. please consult our Customer Care Centre.

OsiSense XMLD pressure switches

Without setting scale

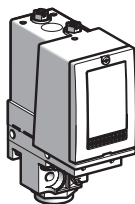

Adjustable range of each switching point (Rising pressure)	2nd stage switching point (PH2)	9.4...70 bar (136.3...1015 psi)
	1st stage switching point (PH1)	6.6...67.2 bar (95.7...974.4 psi)
Spread between 2 stages (PH2 - PH1)		2.8...46 bar (40.6...667 psi)
Electrical connection	Terminals	
Fluid connection	G 1/4 (female)	1/4"-18 NPTF (female)

References (1)

Fluids controlled (2)	Hydraulic oils, up to + 160 °C	XMLD070D1S12	XMLD070D1S13
	Corrosive fluids, air, up to + 160 °C	XMLD070N1S12	-
Weight (kg)		0.715	0.715

Complementary characteristics not shown under general characteristics (page 17)

Natural differential (subtract from PH1/PH2 to give PB1/PB2)	At low setting (3)	5 bar (72.5 psi)
	At high setting (4)	9.5 bar (137.75 psi)
Maximum permissible pressure	Per cycle	90 bar (1035 psi)
	Accidental	160 bar (2320 psi)
Destruction pressure		320 bar (4640 psi)
Mechanical life		6 x 10 ⁸ operating cycles
Cable entry for terminal models		1 entry tapped M20 x 1.5 mm for ISO cable gland, clamping capacity 7 to 13 mm
		1 entry tapped 1/2"-14 NPT for cable gland, clamping capacity 7 to 13 mm
Pressure switch type		Piston

(1) For 1 entry tapped for no. 13 cable gland, replace S12 with S11 (for example, XMLD070D1S12 becomes XMLD070D1S11).

(2) For component materials of units in contact with the fluid, see pages 72 and 73.

(3) Deviation of the differential at low setting point for switches of the same size:
± 1.5 bar (± 21.75 psi)

(4) Deviation of the differential at high setting point for switches of the same size:
± 2 bar (± 29 psi)

Operating curves

High setting tripping points of contacts 1 and 2

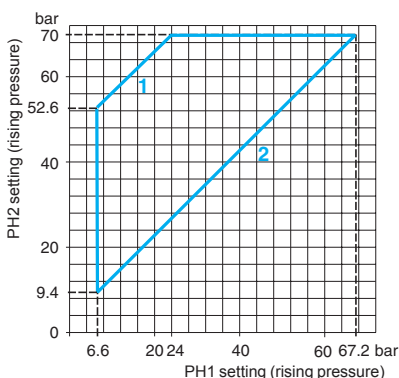

- 1 Maximum differential
- 2 Minimum differential

Natural differential of contacts 1 and 2

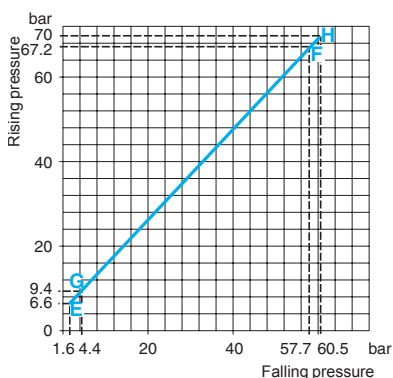

- EF Contact 1 (stage 1)
- GH Contact 2 (stage 2)

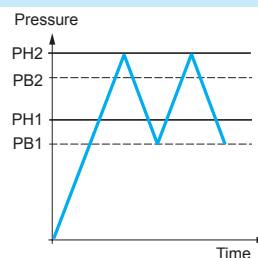

— Adjustable value
--- Non adjustable value

Connection

Terminal model

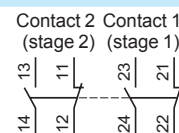

Other versions

For pressure switches with alternative tapped cable entries, such as NPT, etc. please consult our Customer Care Centre.

Electromechanical pressure switches

OsiSense XML

Size 160 bar (2320 psi)

Fixed differential, for detection of a single threshold

Switches with 1 CO single-pole contact

OsiSense XMLA pressure switches

With setting scale

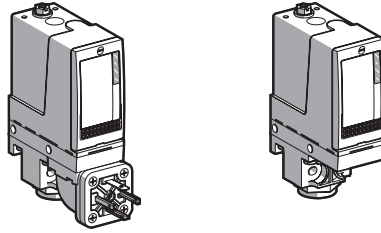

Adjustable range of switching point (PH) (Rising pressure)	10...160 bar (145...2320 psi)		
Electrical connection	DIN connector	Terminals	
Fluid connection	G 1/4 (female)	G 1/4 (female)	1/4"-18 NPTF (female)

References (1)

Fluids controlled (2)	Hydraulic oils, up to + 160 °C	XMLA160D2C11	XMLA160D2S12	XMLA160D2S13
	Fresh water, up to + 160 °C	XMLA160E2C11	XMLA160E2S12	XMLA160E2S13
	Corrosive fluids, air, up to + 160 °C	XMLA160N2C11	XMLA160N2S12	—
Weight (kg)		0.780	0.750	0.750

Complementary characteristics not shown under general characteristics (page 17)

Natural differential (subtract from PH to give PB)	At low setting (3)	5.5 bar (79.75 psi)		
	At high setting (4)	18 bar (261 psi)		
Maximum permissible pressure	Per cycle	200 bar (2900 psi)		
	Accidental	360 bar (5220 psi)		
Destruction pressure		720 bar (10,440 psi)		
Mechanical life		6 x 10 ⁶ operating cycles		
Connection		EN 175301-803-A (ex-DIN 43650A), 4-pin male connector. For suitable female connector, see page 68	1 entry tapped M20 x 1.5 mm for ISO cable gland, clamping capacity 7 to 13 mm	1 entry tapped 1/2"-14 NPT for cable gland, clamping capacity 7 to 13 mm
	Pressure switch type	Piston		

- (1) For 1 entry tapped for no. 13 cable gland, replace S12 with S11 (for example, XMLA160D2S12 becomes XMLA160D2S11).
 (2) For component materials of units in contact with the fluid, see pages 72 and 73.
 (3) Deviation of the differential at low setting point for switches of the same size:
 ± 1 bar (± 14.5 psi)
 (4) Deviation of the differential at high setting point for switches of the same size:
 ± 3 bar (± 43.5 psi)

Operating curves

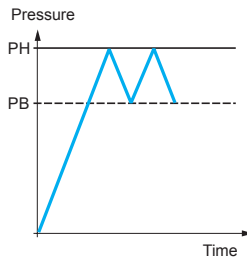
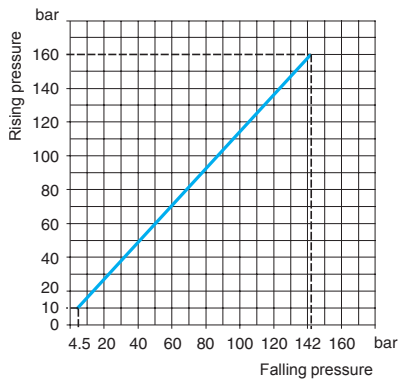

Connection

Terminal model



Connector model

Pressure switch connector pin view

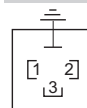

- 1 → 11 and 13
 2 → 12
 3 → 14

- Adjustable value
 --- Non adjustable value

Other versions

For pressure switches with alternative tapped cable entries, such as NPT, etc. please consult our Customer Care Centre.

Electromechanical pressure switches

OsiSense XML

Size 160 bar (2320 psi)

Adjustable differential, for regulation between 2 thresholds

Switches with 1 CO single-pole contact

OsiSense XMLB pressure switches

With setting scale

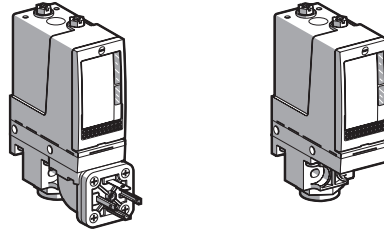

Adjustable range of switching point (PH) (Rising pressure)	10...160 bar (145...2320 psi)		
Electrical connection	DIN connector	Terminals	
Fluid connection	G 1/4 (female)	G 1/4 (female)	1/4"-18 NPTF (female)

References (1)

Fluids controlled (2)	Hydraulic oils, up to + 160 °C	XMLB160D2C11	XMLB160D2S12	XMLB160D2S13
	Fresh water, up to + 160 °C	XMLB160E2C11	XMLB160E2S12	—
	Corrosive fluids, air, up to + 160 °C	XMLB160N2C11	XMLB160N2S12	—
Weight (kg)		0.780	0.750	0.750

Complementary characteristics not shown under general characteristics (page 17)

Possible differential (subtract from PH to give PB)	Min. at low setting (3)	9.3 bar (134.85 psi)	
	Min. at high setting (4)	20.8 bar (301.6 psi)	
	Max. at high setting	100 bar (1450 psi)	
Maximum permissible pressure	Per cycle	200 bar (2900 psi)	
	Accidental	360 bar (5220 psi)	
Destruction pressure		720 bar (10,440 psi)	
Mechanical life		6 x 10 ⁸ operating cycles	
Connection	EN 175301-803-A (ex-DIN 43650A), 4-pin male connector. For suitable female connector, see page 68	1 entry tapped M20 x 1.5 mm for ISO cable gland, clamping capacity 7 to 13 mm	1 entry tapped 1/2"-14 NPT for cable gland, clamping capacity 7 to 13 mm
Pressure switch type	Piston		

(1) For 1 entry tapped for no. 13 cable gland, replace S12 with S11 (for example, XMLB160D2S12 becomes XMLB160D2S11).

(2) For component materials of units in contact with the fluid, see pages 72 and 73.

(3) Deviation of the differential at low setting point for switches of the same size:
- 1.8 bar, + 1.5 bar (- 26.1 psi, + 21.75 psi).

(4) Deviation of the differential at high setting point for switches of the same size:
- 1.9 bar, + 1.6 bar (- 27.55 psi, + 23.2 psi).

Operating curves

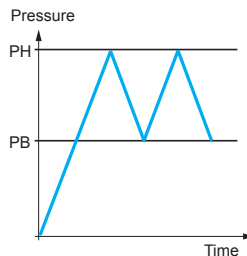
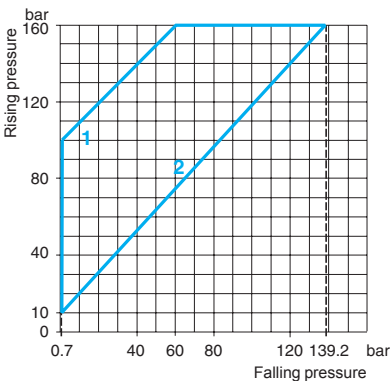

Connection

Terminal model



Connector model

Pressure switch connector pin view

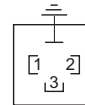

- 1 → 11 and 13
- 2 → 12
- 3 → 14

- 1 Maximum differential
- 2 Minimum differential

— Adjustable value

Other versions

For pressure switches with alternative tapped cable entries, such as NPT, etc. please consult our Customer Care Centre.

Electromechanical pressure switches

OsiSense XML

Size 160 bar (2320 psi)

Adjustable differential, for regulation between 2 thresholds

Switches with 2 CO single-pole contacts

OsiSense XMLC pressure switches

With setting scale

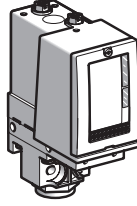

Adjustable range of switching point (PH) (Rising pressure)	12...160 bar (174...2320 psi)	
Electrical connection	Terminals	
Fluid connection	G 1/4 (female)	1/4"-18 NPTF (female)

References (1)

Fluids controlled (2)	Hydraulic oils, up to + 160 °C	XMLC160D2S12	XMLC160D2S13
	Fresh water, up to + 160 °C	XMLC160E2S12	-
	Corrosive fluids, air, up to + 160 °C	XMLC160N2S12	-
Weight (kg)	0.750		0.750

Complementary characteristics not shown under general characteristics (page 17)

Possible differential (subtract from PH to give PB)	Min. at low setting (3)	9 bar (130.5 psi)	
	Min. at high setting (3)	21 bar (304.5 psi)	
	Max. at high setting	110 bar (1590 psi)	
Maximum permissible pressure	Per cycle	200 bar (2900 psi)	
	Accidental	360 bar (5220 psi)	
Destruction pressure	720 bar (10 440 psi)		
Mechanical life	6 x 10 ⁶ operating cycles		
Cable entry for terminal models	1 entry tapped M20 x 1.5 mm for ISO cable gland, clamping capacity 7 to 13 mm		1 entry tapped 1/2"-14 NPT for cable gland, clamping capacity 7 to 13 mm
Pressure switch type	Piston		

(1) For 1 entry tapped for no. 13 cable gland, replace S12 with S11 (for example, XMLC160D2S12 becomes XMLC160D2S11).

(2) For component materials of units in contact with the fluid, see pages 72 and 73.

(3) Deviation of the differential at low and high setting points for switches of the same size:
± 0.9 bar (± 13.05 psi)

Operating curves

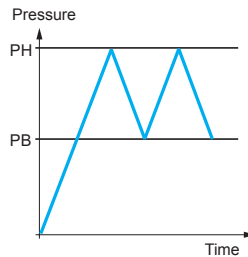
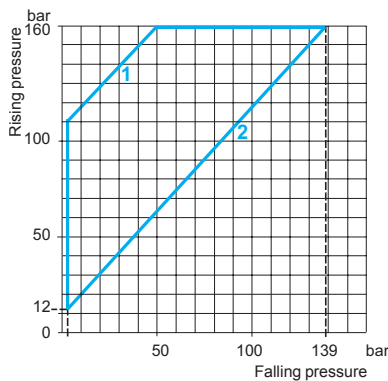

Connection

Terminal model

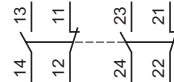

- 1 Maximum differential
- 2 Minimum differential

— Adjustable value

Other versions

For pressure switches with alternative tapped cable entries, such as NPT, etc. please consult our Customer Care Centre.

Electromechanical pressure switches

OsiSense XML

Size 160 bar (2320 psi)

Dual stage, fixed differential, for detection at each threshold

Switches with 2 CO single-pole contacts

OsiSense XMLD pressure switches

Without setting scale

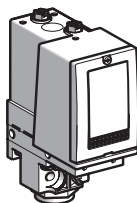

Adjustable range of each switching point (Rising pressure)	2nd stage switching point (PH2)	16.5...160 bar (239.25...2320 psi)
	1st stage switching point (PH1)	10.5...154 bar (152.25...2233 psi)
Spread between 2 stages (PH2 - PH1)		6...83 bar (87...1203.5 psi)
Electrical connection		Terminals
Fluid connection		G 1/4 (female) 1/4"-18 NPTF (female)

References (1)

Fluids controlled (2)	Hydraulic oils, up to + 160 °C	XMLD160D1S12	XMLD160D1S13
	Fresh water, up to + 160 °C	XMLD160E1S12	—
Weight (kg)		0.750	0.750

Complementary characteristics not shown under general characteristics (page 17)

Natural differential (subtract from PH1/PH2 to give PB1/PB2)	At low setting (3)	8.8 bar (127.6 psi)
	At high setting (4)	20 bar (290 psi)
Maximum permissible pressure	Per cycle	200 bar (2900 psi)
	Accidental	360 bar (5220 psi)
Destruction pressure		720 bar (10,440 psi)
Mechanical life		6 x 10 ⁹ operating cycles
Cable entry for terminal models		1 entry tapped M20 x 1.5 mm for ISO cable gland, clamping capacity 7 to 13 mm 1 entry tapped 1/2"-14 NPT for cable gland, clamping capacity 7 to 13 mm
Pressure switch type		Piston

(1) For 1 entry tapped for no. 13 cable gland, replace S12 with S11 (for example, XMLD160D1S12 becomes XMLD160D1S11).

(2) For component materials of units in contact with the fluid, see pages 72 and 73.

(3) Deviation of the differential at low setting point for switches of the same size:
± 1.5 bar (± 21.75 psi)

(4) Deviation of the differential at high setting point for switches of the same size:
± 7 bar (± 101.5 psi)

Operating curves

High setting tripping points of contacts 1 and 2

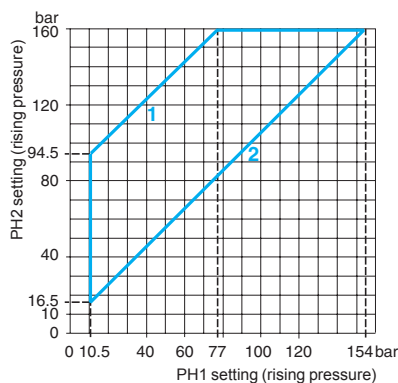

- 1 Maximum differential
- 2 Minimum differential

Natural differential of contacts 1 and 2

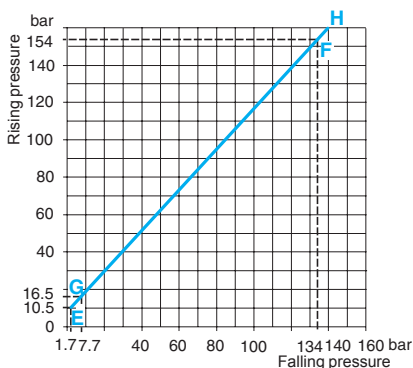

- EF Contact 1 (stage 1)
- GH Contact 2 (stage 2)

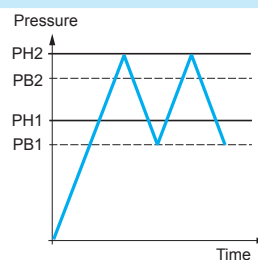

— Adjustable value
--- Non adjustable value

Connection Terminal model

Contact 2 Contact 1
(stage 2) (stage 1)

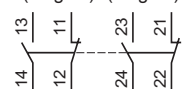

Other versions

For pressure switches with alternative tapped cable entries, such as NPT, etc. please consult our Customer Care Centre.

Electromechanical pressure switches

OsiSense XML

Size 300 bar (4350 psi)

Fixed differential, for detection of a single threshold

Switches with 1 CO single-pole contact

OsiSense XMLA pressure switches

With setting scale

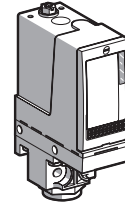
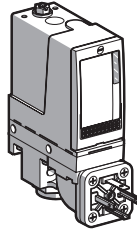

Adjustable range of switching point (PH) (Rising pressure)	20...300 bar (290...4350 psi)		
Electrical connection	DIN connector	Terminals	
Fluid connection	G 1/4 (female)	G 1/4 (female)	1/4"-18 NPTF (female)

References (1)

Fluids controlled (2) (5)	Hydraulic oils, up to + 160 °C	XMLA300D2C11	XMLA300D2S12	XMLA300D2S13
	Fresh water, up to + 160 °C	XMLA300E2C11	XMLA300E2S12	XMLA300E2S13
	Corrosive fluids, air, up to + 160 °C	XMLA300N2C11	XMLA300N2S12	—
Weight (kg)		0.780	0.750	0.750

Complementary characteristics not shown under general characteristics (page 17)

Natural differential (subtract from PH to give PB)	At low setting (3)	16.5 bar (239.25 psi)		
	At high setting (4)	35 bar (507.5 psi)		
Maximum permissible pressure	Per cycle	375 bar (5437.5 psi)		
	Accidental	675 bar (9787.5 psi)		
Destruction pressure		1350 bar (19 575 psi)		
Mechanical life		3 x 10 ⁶ operating cycles		
Connection		EN 175301-803-A (ex-DIN 43650A), 4-pin male connector. For suitable female connector, see page 68	1 entry tapped M20 x 1.5 mm for ISO cable gland, clamping capacity 7 to 13 mm	1 entry tapped 1/2"-14 NPT for cable gland, clamping capacity 7 to 13 mm
Pressure switch type		Piston		

- (1) For 1 entry tapped for no. 13 cable gland, replace S12 with S11 (for example, XMLA300D2S12 becomes XMLA300D2S11).
- (2) For component materials of units in contact with the fluid, see pages 72 and 73.
- (3) Deviation of the differential at low setting point for switches of the same size:
± 3 bar (± 43.5 psi)
- (4) Deviation of the differential at high setting point for switches of the same size:
± 6 bar (± 87 psi)
- (5) Only for control of group 2 fluids, in accordance with directive 97/23/EEC.

Operating curves

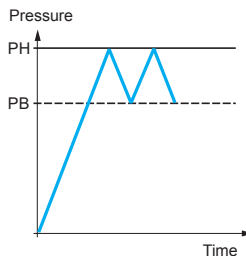
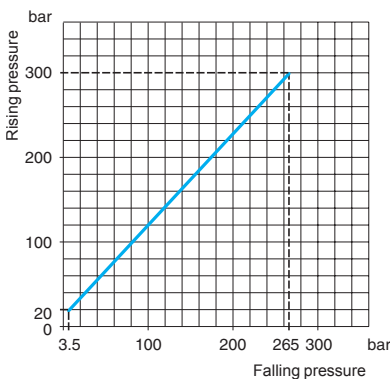

Connection

Terminal model



Connector model

Pressure switch connector pin view

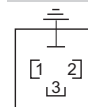

- 1 → 11 and 13
- 2 → 12
- 3 → 14

- Adjustable value
- Non adjustable value

Other versions

For pressure switches with alternative tapped cable entries, such as NPT, etc. please consult our Customer Care Centre.

Electromechanical pressure switches

OsiSense XML

Size 300 bar (4350 psi)

Adjustable differential, for regulation between 2 thresholds

Switches with 1 CO single-pole contact

OsiSense XMLB pressure switches

With setting scale

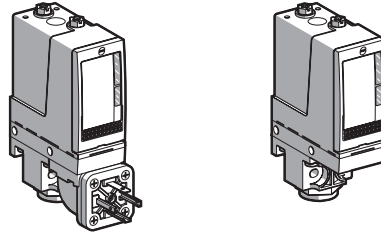

Adjustable range of switching point (PH) (Rising pressure)	22...300 bar (319...4350 psi)		
Electrical connection	DIN connector	Terminals	
Fluid connection	G 1/4 (female)	G 1/4 (female)	1/4"-18 NPTF (female)

References (1)

Fluids controlled (2)(5)	Hydraulic oils, up to + 160 °C	XMLB300D2C11	XMLB300D2S12	XMLB300D2S13
	Fresh water, up to + 160 °C	XMLB300E2C11	XMLB300E2S12	—
	Corrosive fluids, air, up to + 160 °C	XMLB300N2C11	XMLB300N2S12	—
Weight (kg)		0.780	0.750	0.750

Complementary characteristics not shown under general characteristics (page 17)

Possible differential (subtract from PH to give PB)	Min. at low setting (3)	19.4 bar (281.3 psi)		
	Min. at high setting (4)	37 bar (536.5 psi)		
	Max. at high setting	200 bar (2900 psi)		
Maximum permissible pressure	Per cycle	375 bar (5437.5 psi)		
	Accidental	675 bar (9787.5 psi)		
Destruction pressure		1350 bar (19,575 psi)		
Mechanical life		3 x 10 ⁹ operating cycles		
Connection		EN 175301-803-A (ex-DIN 43650A), 4-pin male connector. For suitable female connector, see page 68	1 entry tapped M20 x 1.5 mm for ISO cable gland, clamping capacity 7 to 13 mm	1 entry tapped 1/2"-14 NPT for cable gland, clamping capacity 7 to 13 mm
	Pressure switch type	Piston		

(1) For 1 entry tapped for no. 13 cable gland, replace S12 with S11 (for example, XMLB300D2S12 becomes XMLB300D2S11).

(2) For component materials of units in contact with the fluid, see pages 72 and 73.

(3) Deviation of the differential at low setting point for switches of the same size:
- 1.5 bar, + 1.7 bar (- 21.75 psi, + 24.65 psi).

(4) Deviation of the differential at high setting point for switches of the same size:
- 1 bar, + 4 bar (- 14.5 psi, + 58 psi).

(5) Only for control of group 2 fluids, in accordance with directive 97/23/EEC.

Operating curves

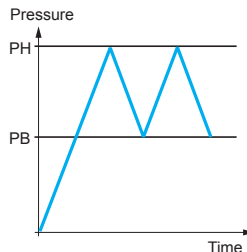
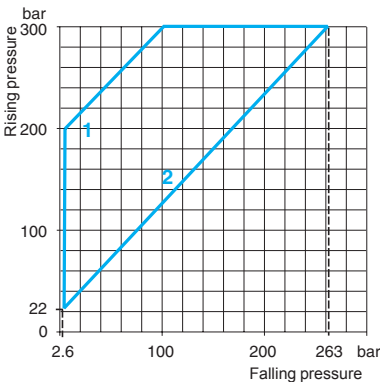

Connection

Terminal model



Connector model

Pressure switch connector pin view

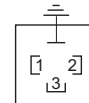

1 → 11 and 13
2 → 12
3 → 14

- 1 Maximum differential
- 2 Minimum differential

— Adjustable value

Other versions

For pressure switches with alternative tapped cable entries, such as NPT, etc. please consult our Customer Care Centre.

Electromechanical pressure switches

OsiSense XML

Size 300 bar (4350 psi)

Adjustable differential, for regulation between 2 thresholds

Switches with 2 CO single-pole contacts

OsiSense XMLC pressure switches

With setting scale

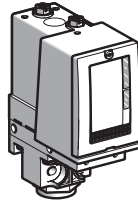

Adjustable range of switching point (PH) (Rising pressure)	22...300 bar (319...4350 psi)
Electrical connection	Terminals
Fluid connection	G 1/4 (female)

References (1)

Fluids controlled (2) (4)	Hydraulic oils, up to + 160 °C	XMLC300D2S12
	Fresh water, up to + 160 °C	XMLC300E2S12
	Corrosive fluids, air, up to + 160 °C	XMLC300N2S12
Weight (kg)		0.750

Complementary characteristics not shown under general characteristics (page 17)

Possible differential (subtract from PH to give PB)	Min. at low setting (3)	16 bar (232 psi)
	Min. at high setting (3)	35 bar (507.5 psi)
	Max. at high setting	240 bar (3480 psi)
Maximum permissible pressure	Per cycle	375 bar (5437.5 psi)
	Accidental	675 bar (9787.5 psi)
Destruction pressure		1350 bar (19 575 psi)
Mechanical life		3 x 10 ⁶ operating cycles
Cable entry for terminal models		1 entry tapped M20 x 1.5 mm for ISO cable gland, clamping capacity 7 to 13 mm
Pressure switch type		Piston

(1) For 1 entry tapped for no. 13 cable gland, replace S12 with S11 (for example, XMLC300D2S12 becomes XMLC300D2S11).

(2) For component materials of units in contact with the fluid, see pages 72 and 73.

(3) Deviation of the differential at low and high setting points for switches of the same size:
± 0.9 bar (± 13.05 psi)

(4) Only for control of group 2 fluids, in accordance with directive 97/23/EEC.

Operating curves

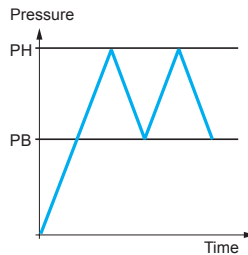
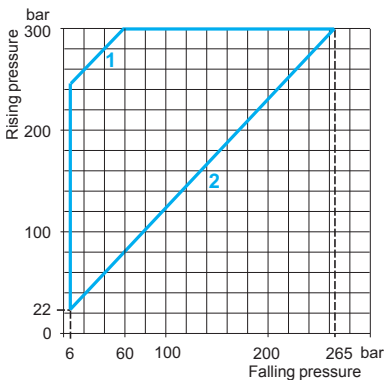

Connection

Terminal model

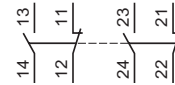

- 1 Maximum differential
- 2 Minimum differential

— Adjustable value

Other versions

For pressure switches with alternative tapped cable entries, such as NPT, etc. please consult our Customer Care Centre.

Electromechanical pressure switches

OsiSense XML

Size 300 bar (4350 psi)

Dual stage, fixed differential, for detection at each threshold

Switches with 2 CO single-pole contacts

OsiSense XMLD pressure switches

Without setting scale

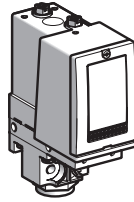

Adjustable range of each switching point (Rising pressure)	2nd stage switching point (PH2) 1st stage switching point (PH1)	36...300 bar (522...4350 psi) 25...289 bar (362.5...4190.5 psi)
Spread between 2 stages (PH2 - PH1)		11...189 bar (159.5...2740.5 psi)
Electrical connection	Terminals	
Fluid connection	G 1/4 (female)	1/4"-18 NPTF (female)

References (1)

Fluids controlled (2) (5)	Hydraulic oils, up to + 160 °C	XMLD300D1S12	XMLD300D1S13
	Fresh water, up to + 160 °C	XMLD300E1S12	—
	Corrosive fluids, air, up to + 160 °C	XMLD300N1S12	—
Weight (kg)		0.750	0.750

Complementary characteristics not shown under general characteristics (page 17)

Natural differential (subtract from PH1/PH2 to give PB1/PB2)	At low setting (3)	17 bar (246.5 psi)
	At high setting (4)	42 bar (609 psi)
Maximum permissible pressure	Per cycle	375 bar (5437.5 psi)
	Accidental	675 bar (9787.5 psi)
Destruction pressure		1350 bar (19,575 psi)
Mechanical life		3 x 10 ⁸ operating cycles
Cable entry for terminal models		1 entry tapped M20 x 1.5 mm for ISO cable gland, clamping capacity 7 to 13 mm
		1 entry tapped 1/2"-14 NPT for cable gland, clamping capacity 7 to 13 mm
Pressure switch type		Piston

(1) For 1 entry tapped for no. 13 cable gland, replace **S12** with **S11** (for example, **XMLD300D1S12** becomes **XMLD300D1S11**).

(2) For component materials of units in contact with the fluid, see pages 72 and 73.

(3) Deviation of the differential at low setting point for switches of the same size:
± 2.5 bar (± 36.25 psi)

(4) Deviation of the differential at high setting point for switches of the same size:
± 9 bar (± 130.5 psi)

(5) Only for control of group 2 fluids, in accordance with directive 97/23/EEC.

Operating curves

High setting tripping points of contacts 1 and 2

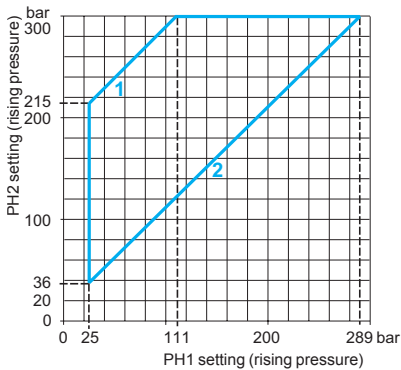

- 1 Maximum differential
- 2 Minimum differential

Natural differential of contacts 1 and 2

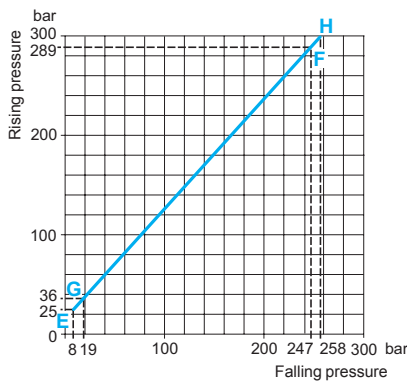

- EF** Contact 1 (stage 1)
GH Contact 2 (stage 2)

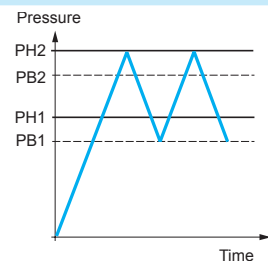

- Adjustable value
--- Non adjustable value

Connection

Terminal model

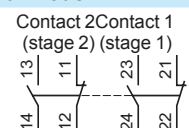

Other versions

For pressure switches with alternative tapped cable entries, such as NPT, etc. please consult our Customer Care Centre.

Electromechanical pressure switches

OsiSense XML

Size 500 bar (7250 psi)

Fixed differential, for detection of a single threshold

Switches with 1 CO single-pole contact

OsiSense XMLA pressure switches

With setting scale

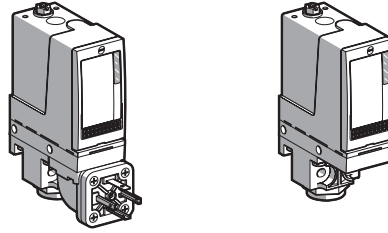

Adjustable range of switching point (PH) (Rising pressure)	30...500 bar (435...7250 psi)		
Electrical connection	DIN connector	Terminals	
Fluid connection	G 1/4 (female)	G 1/4 (female)	1/4"-18 NPTF (female)

References (1)

Fluids controlled (2) (5)	Hydraulic oils, up to + 160 °C	XMLA500D2C11	XMLA500D2S12	XMLA500D2S13
	Fresh water, up to + 160 °C	XMLA500E2C11	XMLA500E2S12	XMLA500E2S13
	Corrosive fluids, air, up to + 160 °C	XMLA500N2C11	XMLA500N2S12	—
Weight (kg)		0.780	0.750	0.750

Complementary characteristics not shown under general characteristics (page 17)

Natural differential (subtract from PH to give PB)	At low setting (3)	20 bar (290 psi)		
	At high setting (4)	45 bar (652.5 psi)		
Maximum permissible pressure	Per cycle	625 bar (9062.5 psi)		
	Accidental	1125 bar (16,312.5 psi)		
Destruction pressure		2250 bar (32,625 psi)		
Mechanical life		3 x 10 ⁶ operating cycles		
Connection		EN 175301-803-A (ex-DIN 43650A), 4-pin male connector. For suitable female connector, see page 68	1 entry tapped M20 x 1.5 mm for ISO cable gland, clamping capacity 7 to 13 mm	1 entry tapped 1/2"-14 NPT for cable gland, clamping capacity 7 to 13 mm
	Pressure switch type	Piston		

- (1) For 1 entry tapped for no. 13 cable gland, replace S12 with S11 (for example, XMLA500D2S12 becomes XMLA500D2S11).
 (2) For component materials of units in contact with the fluid, see pages 72 and 73.
 (3) Deviation of the differential at low setting point for switches of the same size:
 ± 6 bar (± 87 psi)
 (4) Deviation of the differential at high setting point for switches of the same size:
 ± 10 bar (± 145 psi)
 (5) Only for control of group 2 fluids, in accordance with directive 97/23/EEC.

Operating curves

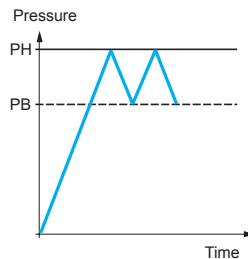
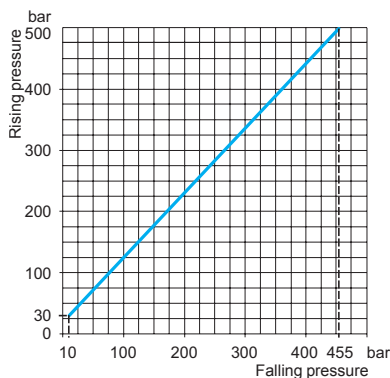

Connection

Terminal model



Connector model

Pressure switch connector pin view

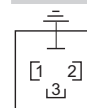

- 1 → 11 and 13
 2 → 12
 3 → 14

- Adjustable value
 --- Non adjustable value

Other versions

For pressure switches with alternative tapped cable entries, such as NPT, etc. please consult our Customer Care Centre.

Electromechanical pressure switches

OsiSense XML

Size 500 bar (7250 psi)

Adjustable differential, for regulation between 2 thresholds

Switches with 1 CO single-pole contact

OsiSense XMLB pressure switches

With setting scale

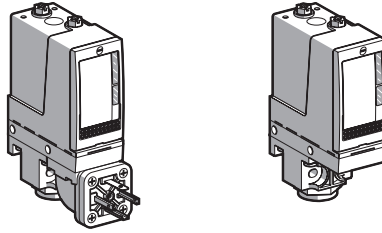

Adjustable range of switching point (PH) (Rising pressure)	30...500 bar (435...7250 psi)		
Electrical connection	DIN connector	Terminals	
Fluid connection	G 1/4 (female)	G 1/4 (female)	1/4"-18 NPTF (female)

References (1)

Fluids controlled (2) (5)	Hydraulic oils, up to + 160 °C	XMLB500D2C11	XMLB500D2S12	XMLB500D2S13
	Fresh water, up to + 160 °C	XMLB500E2C11	XMLB500E2S12	—
	Corrosive fluids, air, up to + 160 °C	XMLB500N2C11	XMLB500N2S12	—
Weight (kg)		0.780	0.750	0.750

Complementary characteristics not shown under general characteristics (page 17)

Possible differential (subtract from PH to give PB)	Min. at low setting (3)	23 bar (333.5 psi)		
	Min. at high setting (4)	52.6 bar (762.7 psi)		
	Max. at high setting	300 bar (4350 psi)		
Maximum permissible pressure	Per cycle	625 bar (9062.5 psi)		
	Accidental	1125 bar (16,312.5 psi)		
Destruction pressure		2250 bar (32,625 psi)		
Mechanical life		3 x 10 ⁸ operating cycles		
Connection		EN 175301-803-A (ex-DIN 43650A), 4-pin male connector. For suitable female connector, see page 68	1 entry tapped M20 x 1.5 mm for ISO cable gland, clamping capacity 7 to 13 mm	1 entry tapped 1/2"-14 NPT for cable gland, clamping capacity 7 to 13 mm
Pressure switch type		Piston		

(1) For 1 entry tapped for no. 13 cable gland, replace S12 with S11 (for example, XMLB500D2S12 becomes XMLB500D2S11).

(2) For component materials of units in contact with the fluid, see pages 72 and 73.

(3) Deviation of the differential at low setting point for switches of the same size:
- 2.6 bar, + 3.8 bar (- 37.7 psi, + 55.1 psi).

(4) Deviation of the differential at high setting point for switches of the same size:
- 14.8 bar, + 11.2 bar (- 214.6 psi, + 162.4 psi).

(5) Only for control of group 2 fluids, in accordance with directive 97/23/EEC.

Operating curves

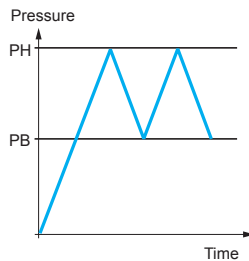
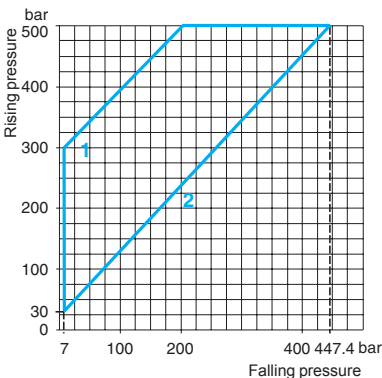

Connection

Terminal model



Connector model

Pressure switch connector pin view

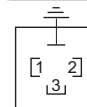

1 → 11 and 13
2 → 12
3 → 14

- 1 Maximum differential
- 2 Minimum differential

— Adjustable value

Other versions

For pressure switches with alternative tapped cable entries, such as NPT, etc. please consult our Customer Care Centre.

Electromechanical pressure switches

OsiSense XML

Size 500 bar (7250 psi)

Adjustable differential, for regulation between 2 thresholds

Switches with 2 CO single-pole contacts

OsiSense XMLC pressure switches

With setting scale

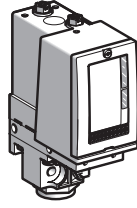

Adjustable range of switching point (PH) (Rising pressure)	30...500 bar (435...7250 psi)
Electrical connection	Terminals
Fluid connection	G 1/4 (female)

References (1)

Fluids controlled (2) (4)	Hydraulic oils, up to + 160 °C	XMLC500D2S12
	Corrosive fluids, air, up to + 160 °C	XMLC500N2S12
Weight (kg)	0.750	

Complementary characteristics not shown under general characteristics (page 17)

Possible differential (subtract from PH to give PB)	Min. at low setting (3)	19 bar (275.5 psi)
	Min. at high setting (3)	52 bar (754 psi)
	Max. at high setting	340 bar (4930 psi)
Maximum permissible pressure	Per cycle	625 bar (9062.5 psi)
	Accidental	1125 bar (16 312.5 psi)
Destruction pressure	2250 bar (32 625 psi)	
Mechanical life	3 x 10 ⁸ operating cycles	
Cable entry for terminal models	1 entry tapped. Je préfère acheter des 5 mm for ISO cable gland, clamping capacity 7 to 13 mm	
Pressure switch type	Piston	

(1) For 1 entry tapped for no. 13 cable gland, replace S12 with S11 (for example, XMLC500D2S12 becomes XMLC500D2S11).

(2) For component materials of units in contact with the fluid, see pages 72 and 73.

(3) Deviation of the differential at low and high setting points for switches of the same size:
± 0.9 bar (± 13.05 psi)

(4) Only for control of group 2 fluids, in accordance with directive 97/23/EEC.

Operating curves

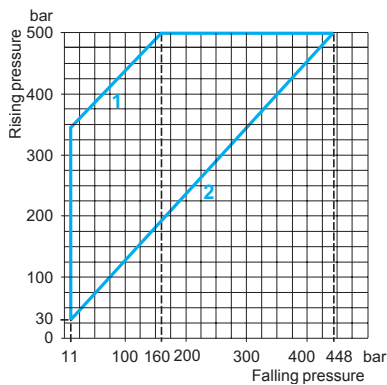

- 1 Maximum differential
- 2 Minimum differential

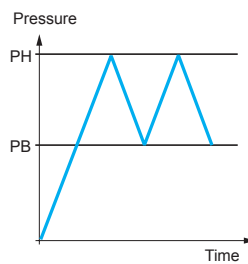

— Adjustable value

Connection

Terminal model

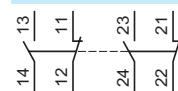

Other versions

For pressure switches with alternative tapped cable entries, such as NPT, etc. please consult our Customer Care Centre.

Electromechanical pressure switches

OsiSense XML

Size 500 bar (7250 psi)

Dual stage, fixed differential, for detection at each threshold

Switches with 2 CO single-pole contacts

OsiSense XMLD pressure switches

Without setting scale

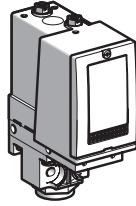

Adjustable range of each switching point (Rising pressure)	2nd stage switching point (PH2) 1st stage switching point (PH1)	41...500 bar (594.5...7250 psi) 25...484 bar (362.5...7018 psi)
Spread between 2 stages (PH2 - PH1)		16...244 bar (232...3538 psi)
Electrical connection		Terminals
Fluid connection		G 1/4 (female)

References (1)

Fluids controlled (2) (5)	Hydraulic oils, up to + 160 °C	XMLD500D1S12
Weight (kg)		0.750

Complementary characteristics not shown under general characteristics (page 17)

Natural differential (subtract from PH1/PH2 to give PB1/PB2)	At low setting (3) At high setting (4)	21 bar (304.5 psi) 65 bar (942.5 psi)
Maximum permissible pressure	Per cycle Accidental	625 bar (9062.5 psi) 1125 bar (16,312.5 psi)
Destruction pressure		2250 bar (32,625 psi)
Mechanical life		3 x 10 ⁶ operating cycles
Cable entry for terminal models		1 entry tapped M20 x 1.5 mm for ISO cable gland, clamping capacity 7 to 13 mm
Pressure switch type		Piston

(1) For 1 entry tapped for no. 13 cable gland, replace **S12** with **S11** (for example, **XMLD500D1S12** becomes **XMLD500D1S11**).

(2) For component materials of units in contact with the fluid, see pages 72 and 73.

(3) Deviation of the differential at low setting point for switches of the same size:
± 3 bar (± 43.5 psi)

(4) Deviation of the differential at high setting point for switches of the same size:
± 10 bar (± 145 psi)

(5) Only for control of group 2 fluids, in accordance with directive 97/23/EEC.

Operating curves

High setting tripping points of contacts 1 and 2

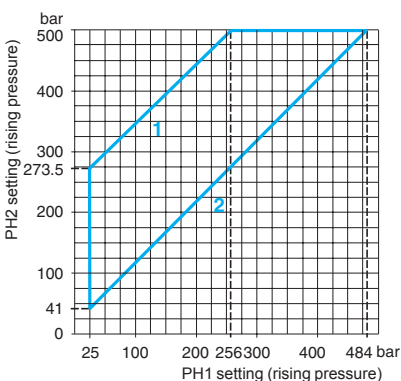

- 1 Maximum differential
- 2 Minimum differential

Natural differential of contacts 1 and 2

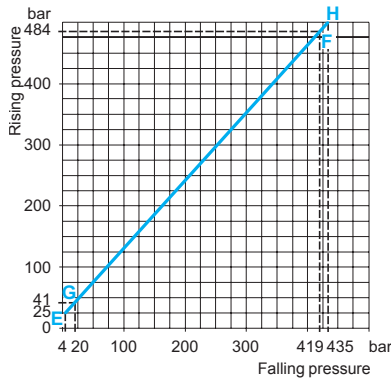

- EF Contact 1 (stage 1)
- GH Contact 2 (stage 2)

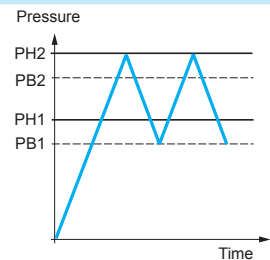

— Adjustable value
--- Non adjustable value

Connection

Terminal model

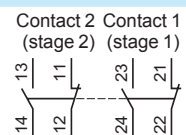

Other versions

For pressure switches with alternative tapped cable entries, such as NPT, etc. please consult our Customer Care Centre.

Electromechanical pressure and vacuum switches

OsiSense XMLA, XMLB, XMLC and XMLD
Accessories and replacement parts

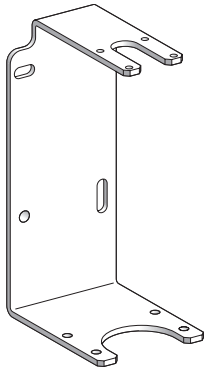

XMLZL006

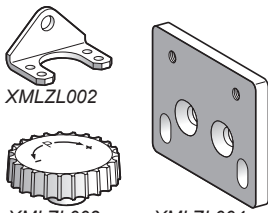

XMLZL002

XMLZL003

XMLZL004

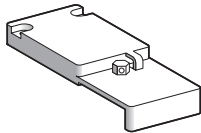

XMLZL001

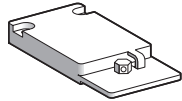

XMLZL011

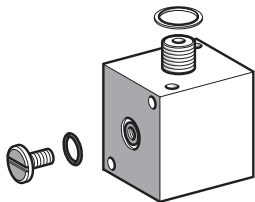

XMLZL005

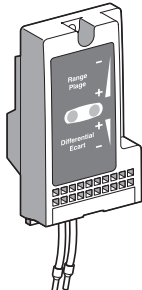

XMLZA●●●,
XMLZB●●●

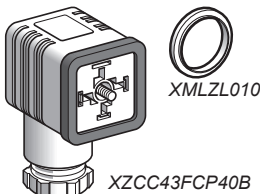

XMLZL010

XZCC43FCP40B

Accessories for pressure switches and vacuum switches

Description	Specific characteristics	For use with switches	Unit reference	Weight kg	
Rear fixing bracket for vibrations > 2 gn	–	XML●L35 XML●001	XMLZL006	0.230	
Additional top support bracket for vibrations > 4 gn	–	XMLAM01 XML●M05 XMLA004 XML●010... XML●500	XMLZL002	0.020	
Knurled adjustment knob, Ø 36 mm fits over adjustment screws to facilitate setting	–	All models	XMLZL003	0.010	
Fixing plate for replacing an XMJA or XMGB switch with an XML switch	–	XMLAM01 XML●M05 XMLA004 XML●010... XML●500	XMLZL004	0.110	
Lead sealable protective cover to prevent unauthorised access to adjustment screws and fixing screw of switch cover	–	XMLA XMLB	XMLZL001	0.035	
Lead sealable protective cover to prevent unauthorised access to adjustment screws	–	All types	XMLZL011	0.030	
Indicator modules and associated covers, 2 LEDs (orange and green)	Without setting scale	~ or ~ 24/48 V	XMLA/B	XMLZZ024	0.090
		~ 110/240 V	XMLA/B	XMLZZ120	0.090
		With setting scale ~ or ~ 24/48 V	XMLA	XMLZA024	0.090
			XMLB	XMLZB024	0.090
		~ 110/240 V	XMLA	XMLZA120	0.090
			XMLB	XMLZB120	0.090
Hydraulic block for base mounting directly onto fluid manifold	–	All types	XMLZL005	0.240	
Female EN 175301-803-A connector (ex-DIN 43650A)	–	XML●●●●●●C11	XZCC43FCP40B	0.035	
Adaptor, G 1/4"/G 3/8" male/female	–	All types	XMLZL012	0.130	

Replacement parts

Sealing gasket (pack of 10 gaskets)	For sizes ≥ 300 bar (XMLA/B/C/D)		XMLZL010	0.015
Diaphragms	–	XML●S35	XMLZL013	0.060
		XML●S02	XMLZL014	0.040
		XML●S04	XMLZL015	0.030

Electromechanical pressure and vacuum switches

OsiSense XMLA, XMLB, XMLC and XMLD

XML●L35, XML●001, XML●S

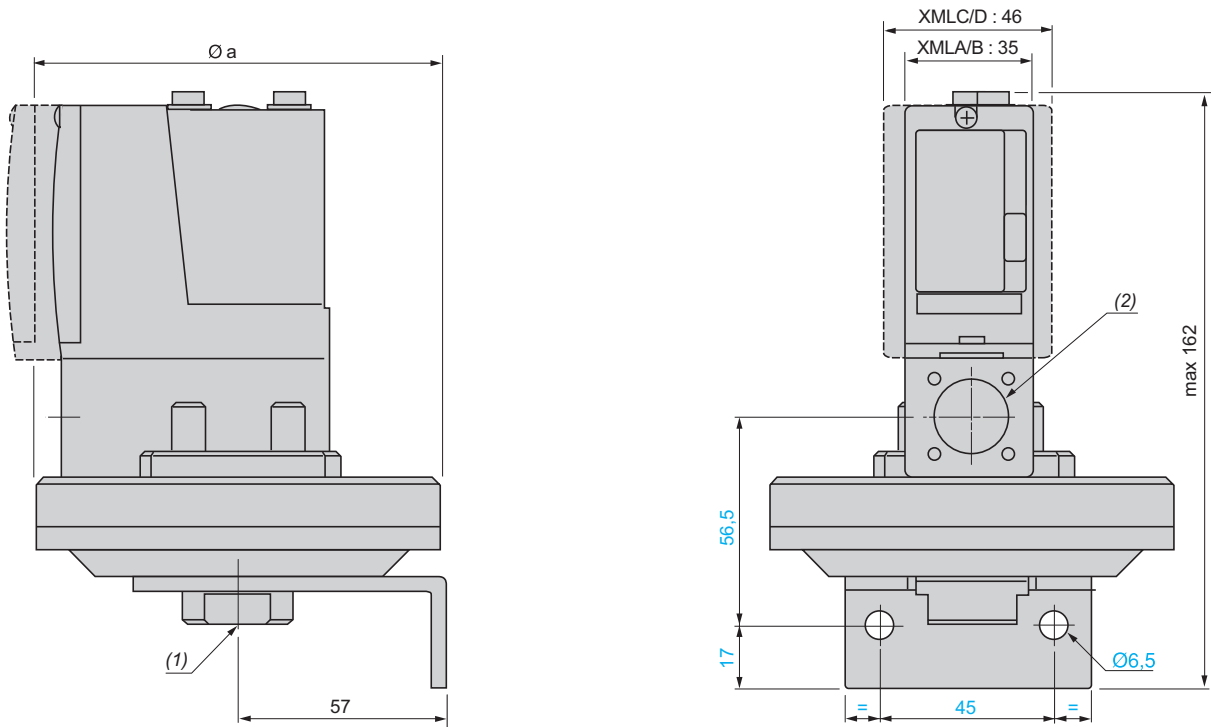

- (1) 1 fluid entry, tapped G 1/4 (female) or 1/4"-18 NPTF (female)
- (2) 1 electrical connections entry, tapped M20 x 1.5 mm or Pg 13.5 or 1/2"-14 NPT

XMLBM03, XMLBL05

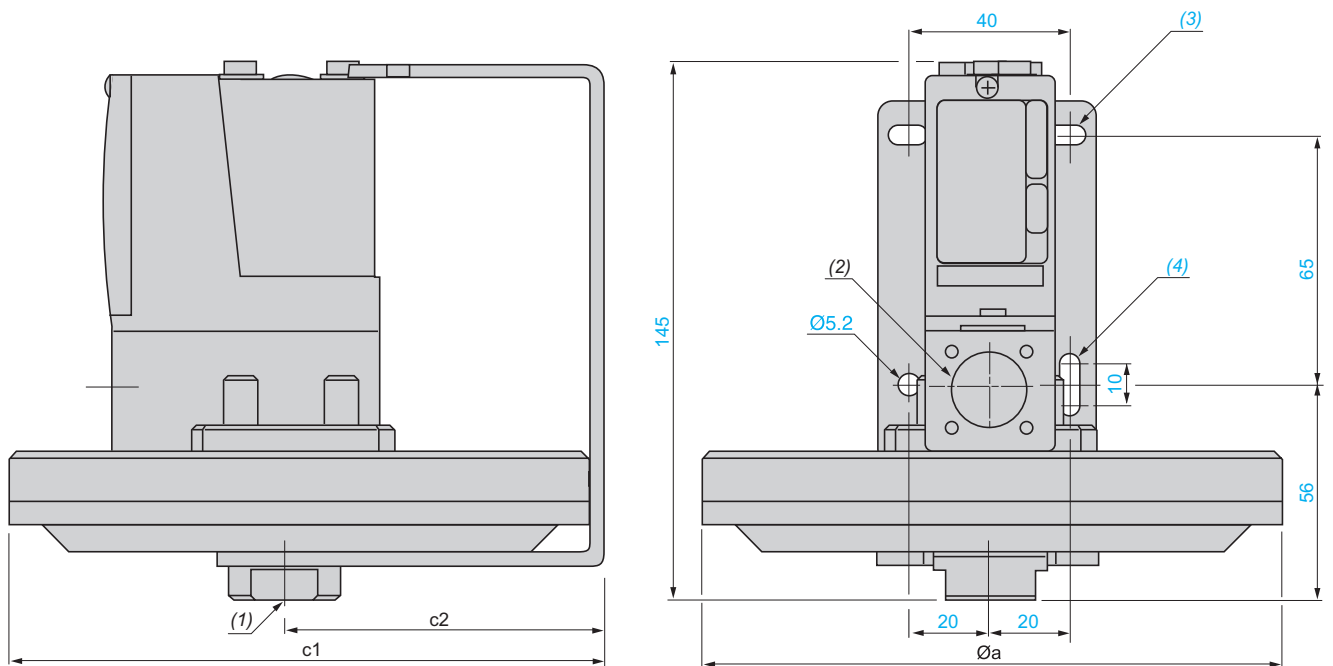

- (1) 1 fluid entry, tapped G 1/4 (female) or 1/4"-18 NPTF (female)
- (2) 1 electrical connections entry, tapped M20 x 1.5 mm or Pg 13.5 or 1/2"-14 NPT
- (3) 2 elongated holes $\text{Ø } 10.2 \times 5.2$
- (4) 1 elongated hole $\text{Ø } 15.2 \times 5.2$

XML	Øa	c1	c2
BM03	150	155.5	80.5
BL05	200	204	104
●L35, ●001	110	-	-
●S35, ●S02, ●S04	110	-	-
●S10, ●S20	86	-	-

Electromechanical pressure and vacuum switches

OsiSense XMLA, XMLB, XMLC and XMLD

XMLAM01, XMLBM05, XMLCM05, XMLA004, XML0010...500

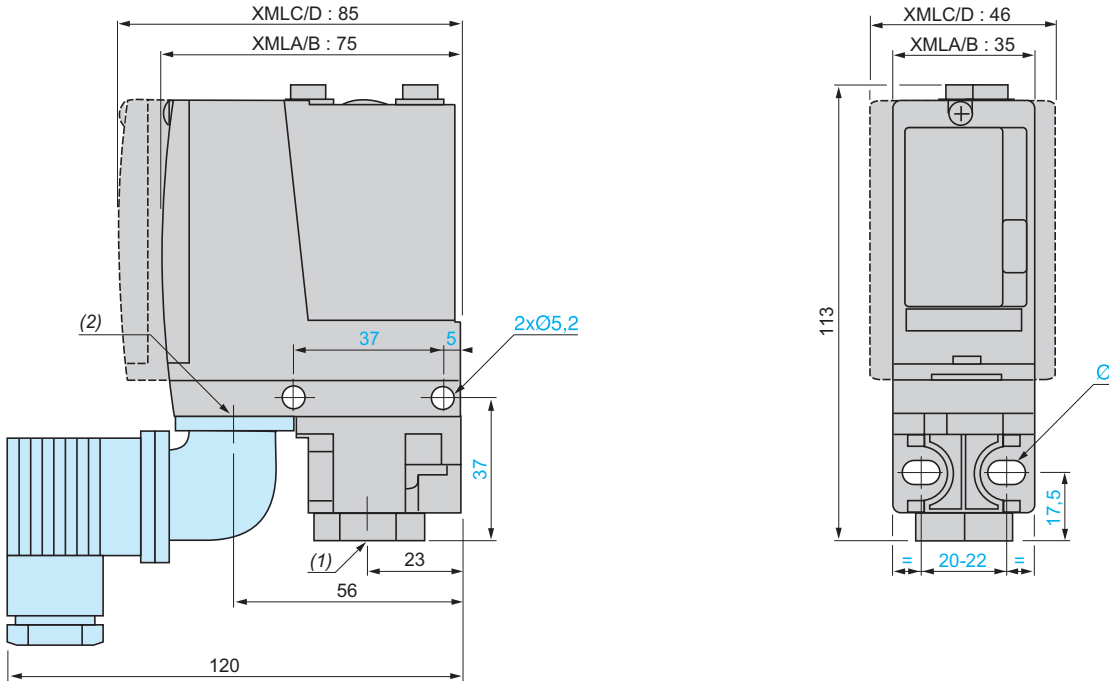

(1) 1 fluid entry, tapped G 1/4 (female) or 1/4"-18 NPTF (female)
 (2) 1 electrical connections entry, tapped M20 x 1.5 mm or Pg 13.5 or 1/2"-14 NPT
 Ø: 2 elongated holes Ø 5.2 x 6.7

XML0M02, XML0002, XMLB004, XMLC004, XMLD004

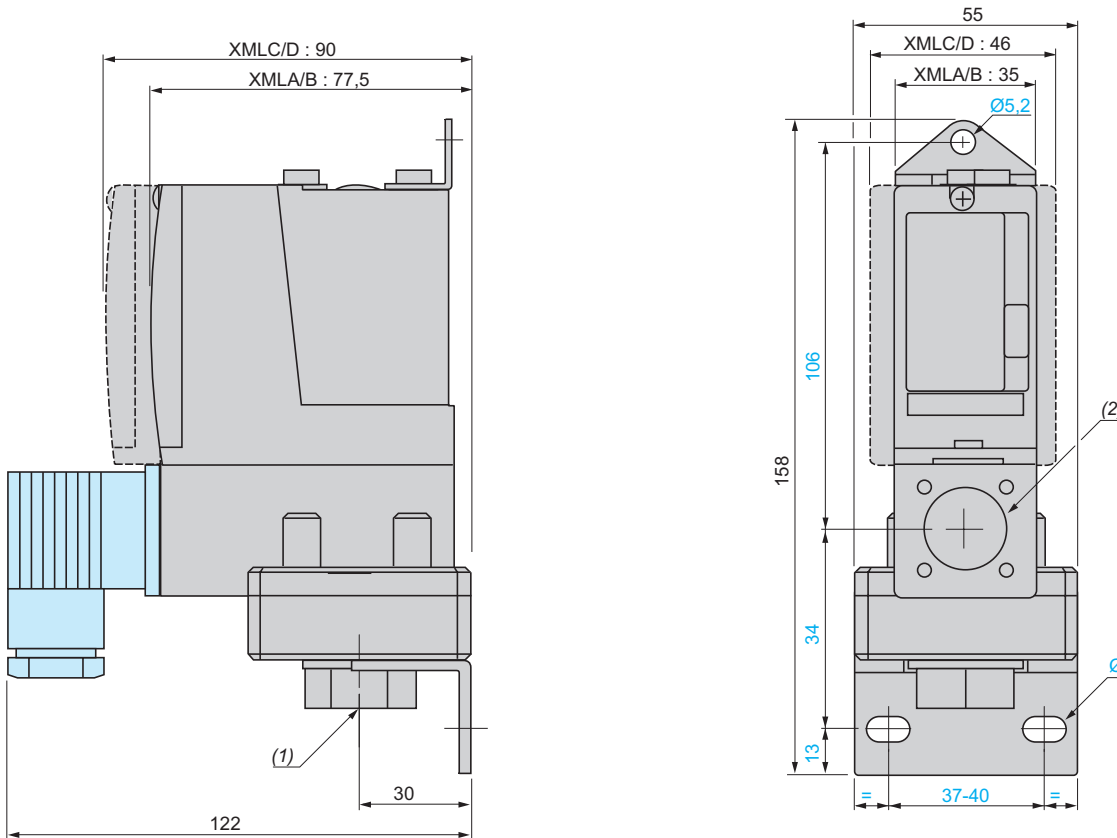

(1) 1 fluid entry, tapped G 1/4 (female) or 1/4"-18 NPTF (female)
 (2) 1 electrical connections entry, tapped M20 x 1.5 mm or Pg 13.5 or 1/2"-14 NPT
 Ø: 2 elongated holes Ø 10.2 x 5.2

Electromechanical pressure and vacuum switches

OsiSense XMLA, XMLB, XMLC and XMLD

XMLBL35P, XMLB001P

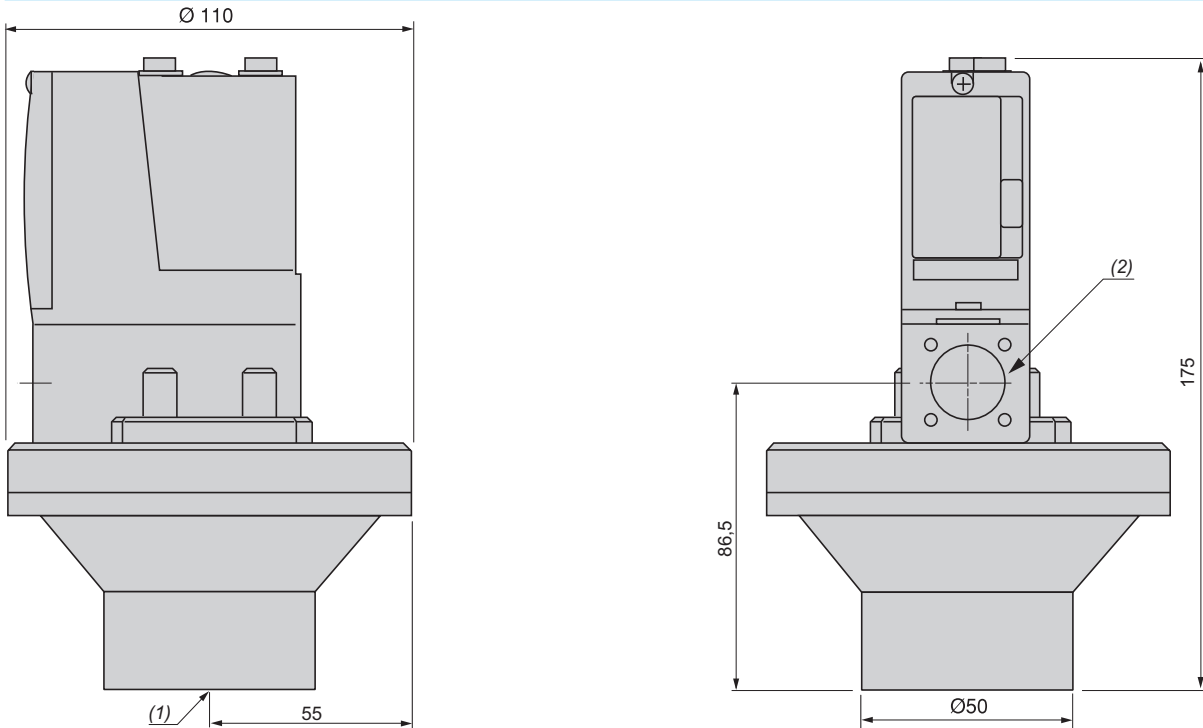

- (1) 1 fluid entry, tapped G 1¼ (female)
- (2) 1 electrical connections entry, tapped M20 x 1.5 mm or Pg 13.5

XMLBM05P, XMLA004P, XML●010P, XML●020P, XML●035P

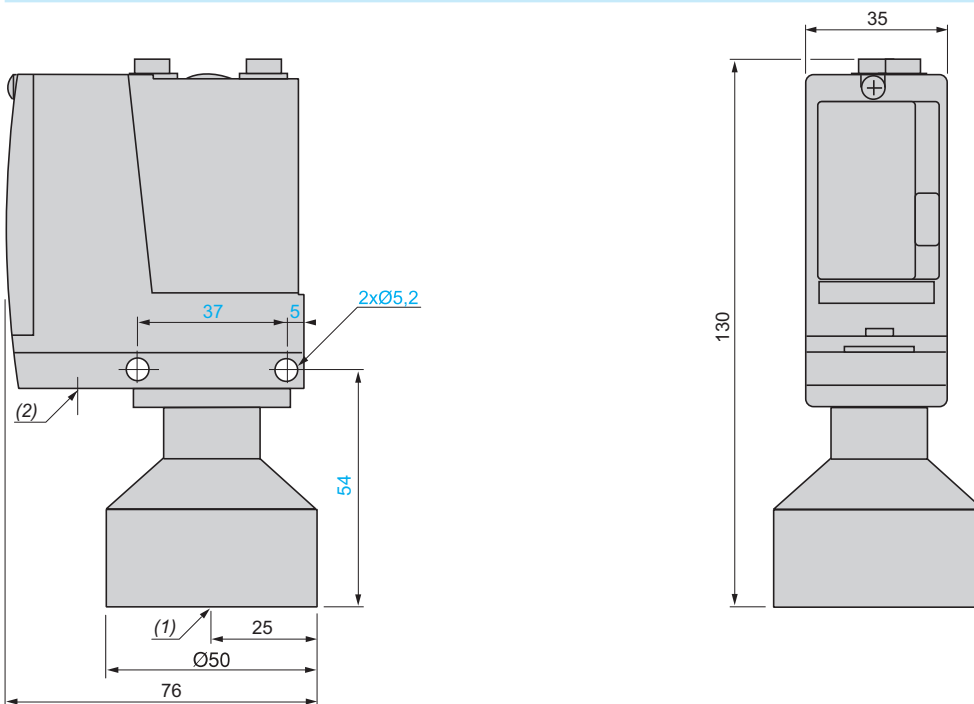

- (1) 1 fluid entry, tapped G 1¼ (female)
- (2) 1 electrical connections entry, tapped M20 x 1.5 mm or Pg 13.5

This information will assist in checking the corrosion resistance of the pressure or vacuum switches in relation to the fluids controlled

Pressure or vacuum switch reference	Component materials in contact with fluid							
	Zinc alloy	Stainless steel	Brass	Steel	Nitrile	PTFE	FPM, FKM	Aluminium
XMLAM01V●●●●, XML●M02V●●●●		(1)						
XMLAM01T●●●●, XML●M02T●●●●		(2)						
XMLBM03R●●●●								
XMLBM03S●●●●		(3)						
XML●M05A●●●●		(1)						
XML●M05B●●●●		(1)						
XML●M05C●●●●		(1)						
XMLBM05P●●●●		(1)						
XMLBL05R●●●●								
XMLBL05S●●●●		(3)						
XML●L35R●●●●, XML●S35R●●●●		(1)						
XML●L35S●●●●		(3)						
XMLBL35P●●●●		(1)						
XML●001R●●●●		(1)						
XML●001S●●●●		(3)						
XMLB001P●●●●		(1)						
XML●002A●●●●								
XML●002B●●●●, XML●S02B●●●●								
XML●002C●●●●		(3)						
XMLA004A●●●●								
XMLA004B●●●●								
XMLA004C●●●●		(2)						
XMLA004P●●●●								

 Component materials in contact with fluid

(1) 1.4307 (AISI 304L)

(2) 1.4404 (AISI 316L)

(3) 1.4305 (AISI 303)

This information will assist in checking the corrosion resistance of the pressure or vacuum switches in relation to the fluids controlled

Pressure switch reference	Component materials in contact with fluid							
	Zinc alloy	Stainless steel	Brass	Steel	Nitrile	PTFE	FPM, FKM	Aluminium
XMLB004A●●●●	■				■			
XML●004B●●●●, XML●S04B●●●●				■			■	
XML●004C●●●●		(3)				■		
XML●010A●●●●	■						■	
XML●010B●●●●			■				■	
XML●010C●●●●		(2)				■		
XML●010P●●●●, XML●S10A●●●●				■			■	
XML●020A●●●●, XML●035A●●●●	■		■		■			■
XML●020B●●●●, XML●035B●●●●			■				■	
XML●020C●●●●, XML●035C●●●●		(2)				■		
XML●020P●●●●, XML●035P●●●●, XML●S20A●●●●				■			■	
XML●070D●●●●, XML●160D●●●●			■	■		■	■	
XML●070E●●●●, XML●160E●●●●		(4)	■			■	■	
XML●070N●●●●, XML●160N●●●●		(5)	■			■	■	
XML●300D●●●●			■	■		■	■	
XML●300E●●●●		(4)	■			■	■	
XML●300N●●●●		(5)	■			■	■	
XML●500D●●●●			■	■		■	■	
XML●500E●●●●			■			■	■	
XML●500N●●●●4		(5)	■			■	■	

■ Component materials in contact with fluid

(2) 1.4404 (AISI 316L)

(3) 1.4305 (AISI 303)

(4) 1.4404 (AISI 316L) + 1.4462

(5) 1.4404 (AISI 316L) + 1.4305 (AISI 303)

Electromechanical pressure switches

OsiSense XM

For control circuits, OsiSense ACW and ADW

Presentation

Pressure switches OsiSense ACW and ADW are switches for control circuits, with an adjustable differential.

Pressure switches OsiSense ACW are used to control the pressure of air, oils and other non corrosive fluids, up to 131 bar.

Pressure switches OsiSense ADW are used to control the pressure of oils (including synthetic), up to 340 bar.

Setting, operating principle

Pressure switches OsiSense ACW

The switching point on falling pressure (low point - PB) is adjusted using screw **1**.

The switching point on rising pressure (high point - PH) is made by adjusting screw **2**. This sets the differential between the low and high points, giving a switching point on rising pressure of the displayed low point setting plus the differential setting.

The two adjustments are completely independent.

Contact block operation

When the rising pressure reaches the high point setting (low point setting + differential setting), contact B (1-2) opens and contact A (3-4) closes. The contacts remain actuated until the pressure falls back to the low point setting.

Pressure switches OsiSense ADW

The switching point on rising pressure (high point - PH) is adjusted using screw **1**.

The switching point on falling pressure (low point - PB) is made by adjusting screw **2**. This sets the differential between the high and low points, giving a switching point on falling pressure of the displayed high point setting minus the differential setting.

The two adjustments are completely independent.

Contact block operation

When the rising pressure reaches the high point setting, contact B (1-2) opens and contact A (3-4) closes. The contacts remain actuated until the pressure falls back to the low point setting (high point setting - differential setting).

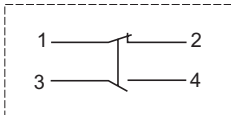
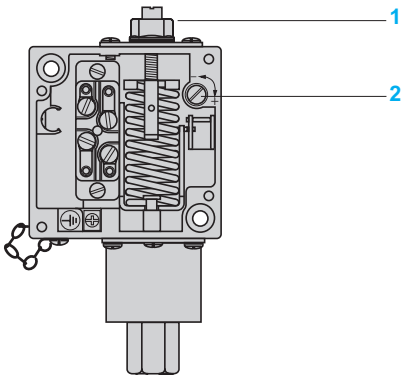
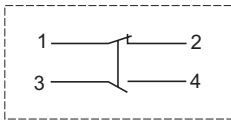
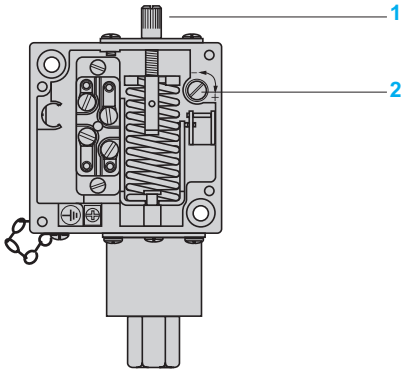

Environment characteristics				
Pressure switch type		ACW (bellows operated)	ADW (piston operated)	
Conformity to standards		CE, IEC/EN 60947-5-1		
Product certifications		CSA, UL (Recognized), EAC		
Protective treatment		"TC"		
Materials		Zinc alloy case Phosphor bronze bellows	Zinc alloy case Pressure switches with drainage hole: Buna N diaphragm, steel piston, cast iron cylinder Pressure switches with Quad-Ring piston seal: Buna N diaphragm, Teflon and Viton seal, stainless steel piston and cylinder	
Ambient air temperature (for operation)	°C	- 56...+ 85	- 30...+ 85	
Fluids controlled		Air, oils and other non corrosive fluids, from - 73 to + 125°C	Oils and other fluids, from - 25 to + 120°C (for ADW5, ADW6, ADW7S1, ADW25 and ADW26) Oils (including synthetic) only, from - 30 to + 125°C (for ADW3, ADW4, ADW7, ADW23, ADW24 and ADW27)	
Degree of protection		IP 65 conforming to IEC/EN 60529		
Fluid connection		G 1/4 (BSP female) conforming to NF E 03-005, ISO 228	G 3/8 (BSP female) conforming to NF E 03-005, ISO 228	
Electrical connection	Terminals	1 tapped entry M20 x 1.5 mm for ISO cable gland. (for ACW●M119012, ACW●●M119012, ADW●M119012 and ADW●●M119012). 1 tapped entry for n° 13 (DIN Pg 13.5) cable gland (for ACW●M129012, ACW●●M129012, ADW●M129012 and ADW●●M129012).		
Contact block characteristics				
Rated operational current	Category AC-15	Ue 24 V 110 V 220 V 500 V	1 CO single-pole pressure switches Ie 5 A 5 A 3 A 1.4 A	2 CO single-pole pressure switches Ie 3 A 3 A 1.5 A 0.7 A
	Category DC-13	Ue 24 V 110 V 220 V 500 V 600 V	Ie 5 A 0.5 A 0.25 A 0.10 A 0.06 A	Ie 1.5 A 0.25 A – – –
Short-circuit protection		10 A cartridge fuse type gG		
Connection		Screw terminals Minimum clamping capacity: 1 x 1 mm ² Maximum clamping capacity: 2 x 2.5 mm ²		

Electromechanical pressure switches

OsiSense XM

For control circuits, OsiSense ACW

Sizes 0.70 to 131 bar (10.15 to 1900 psi)

Adjustable differential, for regulation between 2 thresholds

Fluid connection G 1/4 (female)

Pressure switches OsiSense ACW

Bellows operated



Adjustable range of switching point (PB) (Falling pressure)	0.07...0.70 bar (1.01...10.15 psi)	0.07...1.4 bar (1.01...20.3 psi)	0.07...5.2 bar (1.01...75.4 psi)	0.07...7.6 bar (1.01...110.2 psi)		
References						
Switches with 1 CO single-pole contact						
Electrical connection	With one tapped entry M20 x 1.5 mm for ISO cable gland	ACW3M119012	ACW4M119012	ACW5M119012	ACW1M119012	
	With one tapped entry for n° 13 cable gland	ACW3M129012	ACW4M129012	ACW5M129012	ACW1M129012	
Weight (kg)	1.750		1.550			
Switches with 2 CO single-pole contacts						
Electrical connection	With one tapped entry M20 x 1.5 mm for ISO cable gland	ACW23M119012	ACW24M119012	ACW25M119012	ACW21M119012	
	With one tapped entry for n° 13 cable gland	ACW23M129012	ACW24M129012	ACW25M129012	ACW21M129012	
Weight (kg)	1.750		1.550			
Complementary characteristics not shown under general characteristics (page 75)						
Possible differential (add to PB to give PH)	1 CO switches	Min.	0.04 bar (0.58 psi)	0.10 bar (1.45 psi)	0.30 bar (4.35 psi)	0.50 bar (7.25 psi)
		Max.	0.34 bar (4.93 psi)	0.40 bar (5.8 psi)	1 bar (14.5 psi)	2 bar (29 psi)
	2 CO switches	Min.	0.05 bar (0.73 psi)	0.14 bar (2.03 psi)	0.41 bar (5.95 psi)	0.9 bar (13.05 psi)
		Max.	0.48 bar (6.96 psi)	0.70 bar (10.15 psi)	1.4 bar (20.3 psi)	2.8 bar (40.6 psi)
Maximum permissible pressure		2 bar (29 psi)		7 bar (101.5 psi)	17 bar (246.5 psi)	
Fluids controlled	Air, oils and other non corrosive fluids, from - 73 to + 125°C (1)					
Mechanical life	1 x 10 ⁶ operating cycles (average value, depending on application)					
Cable entry, screw terminals	ACW●M119012, ACW2●M119012	1 tapped entry M20 x 1.5 mm for ISO cable gland. Clamping capacity 7 to 13 mm				
	ACW●M129012, ACW2●M129012	1 tapped entry for n° 13 cable gland, conforming to NF C 68-300 (DIN Pg 13.5). Clamping capacity 9 to 13 mm				

(1) See "Component materials of units in contact with the fluid", page 75.

Operating curve

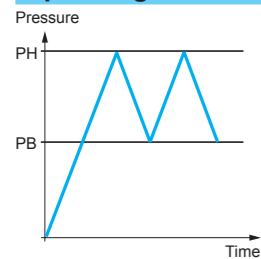

— Adjustable value

Other versions

Contact block connections



Pressure switches with alternative tapped cable entries: NPT, etc. Please consult our Customer Care Centre.

Bellows operated

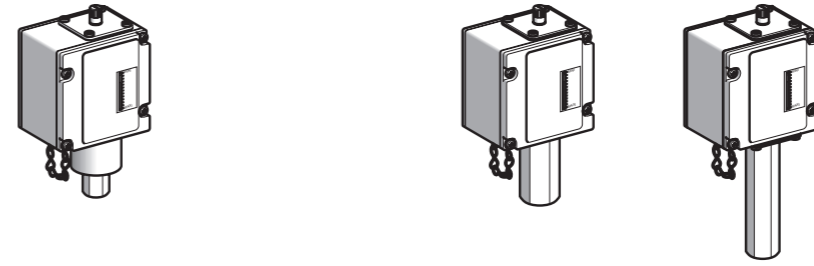

1.4...12 bar (20.3...174 psi)	0.7...18 bar (10.15...261 psi)	0.7...21 bar (10.15...304.5 psi)	5.2...34 bar (75.4...493 psi)	10...69 bar (145...1000 psi)	24...131 bar (348...1900 psi)
References					
Switches with 1 CO single-pole contact					
ACW8M119012	ACW9M119012	ACW2M119012	ACW6M119012	ACW7M119012	ACW10M119012
ACW8M129012	ACW9M129012	ACW2M129012	ACW6M129012	ACW7M129012	ACW10M129012
1.550		2.100			
Switches with 2 CO single-pole contacts					
ACW28M119012	—	ACW22M119012	ACW26M119012	—	ACW20M119012
ACW28M129012	ACW29M129012	ACW22M129012	ACW26M129012	ACW27M129012	ACW20M129012
1.550		2.100			
Complementary characteristics not shown under general characteristics (page 75)					
0.70 bar (10.15 psi)	1 bar (14.5 psi)	1.7 bar (24.7 psi)	3.4 bar (49.3 psi)	5.9 bar (85.6 psi)	11 bar (159.5 psi)
2 bar (29 psi)	1.7 bar (24.7 psi)	8.6 bar (124.7 psi)	8.3 bar (120.4 psi)	10 bar (145 psi)	21 bar (304.5 psi)
1 bar (14.5 psi)	1.6 bar (23.2 psi)	2.4 bar (34.8 psi)	5.9 bar (85.6 psi)	9.3 bar (134.9 psi)	17 bar (246.5 psi)
2.8 bar (40.6 psi)	2.4 bar (34.8 psi)	10 bar (145 psi)	11 bar (159.5 psi)	14 bar (203 psi)	24 bar (348 psi)
17 bar (246.5 psi)	20 bar (290 psi)	41 bar (549.5 psi)	140 bar (2030 psi)	140 bar (2030 psi)	175 bar (2538 psi)
Air, oils and other non corrosive fluids, from - 73 to + 125°C (1)					
1 x 10 ⁶ operating cycles (average value, depending on application)					
1 tapped entry M20 x 1.5 mm for ISO cable gland. Clamping capacity 7 to 13 mm					
1 tapped entry for n° 13 cable gland, conforming to NF C 68-300 (DIN Pg 13.5). Clamping capacity 9 to 13 mm					

Other versions

Pressure switches with alternative tapped cable entries: NPT, etc. Please consult our Customer Care Centre.

Electromechanical pressure switches

OsiSense XM

For control circuits, OsiSense ADW

Sizes 69 to 340 bar (1000 to 4930 psi)

Adjustable differential, for regulation between 2 thresholds

Fluid connection G 3/8 (female)

Pressure switches OsiSense ADW

Piston operated, with drainage hole (1)

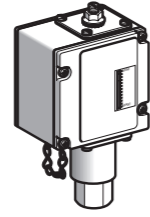

Adjustable range of switching point (PH) (Rising pressure)	9.3...69 bar (135...1000 psi)	28...210 bar (406...3045 psi)	38...340 bar (551...4930 psi)
---	----------------------------------	----------------------------------	----------------------------------

References

Switches with 1 CO single-pole contact

Electrical connection	With one tapped entry M20 x 1.5 mm for ISO cable gland	ADW3M119012	ADW4M119012	ADW7M119012
	With one tapped entry for n° 13 cable gland	ADW3M129012	ADW4M129012	ADW7M129012

Weight (kg)	1.880
-------------	-------

Switches with 2 CO single-pole contacts

Electrical connection	With one tapped entry for n° 13 cable gland	ADW23M129012	ADW24M129012	ADW27M129012
-----------------------	--	--------------	--------------	--------------

Weight (kg)	1.880
-------------	-------

Complementary characteristics not shown under general characteristics (page 75)

Possible differential (subtract from PH to give PB)	1 CO switches	Min.	2.4 bar (34.8 psi)	6.9 bar (100 psi)	8.6 bar (124.7 psi)
		Max.	9.3 bar (135 psi)	28 bar (406 psi)	38 bar (551 psi)
	2 CO switches	Min.	3.1 bar (45 psi)	8.6 bar (124.7 psi)	14 bar (203 psi)
		Max.	14 bar (203 psi)	34 bar (493 psi)	41 bar (594.5 psi)

Maximum permissible pressure	690 bar (10,000 psi)
------------------------------	----------------------

Fluids controlled	Oils (including synthetic) only, from -30°C to +125°C (2) (3)
-------------------	---

Mechanical life	1 x 10 ⁶ operating cycles (average value, depending on application)
-----------------	--

Cable entry, screw terminals	ADW●M119012	1 tapped entry M20 x 1.5 mm for ISO cable gland. Clamping capacity 7 to 13 mm
	ADW●M129012, ADW2●●M129012	1 tapped entry for n° 13 cable gland, conforming to NF C 68-300 (DIN Pg 13.5). Clamping capacity 9 to 13 mm

- (1) Since it is normal for piston type pressure switches (not incorporating a piston seal) to have a slight oil leakage past the piston, a drain hole through the cylinder wall is incorporated. To avoid back pressure, this hole should never be plugged. If for any reason this oil leakage is undesirable, use pressure switches incorporating a Quad-Ring piston seal.
- (2) See "Component materials of units in contact with the fluid", page 75.
- (3) Only for control of group 2 fluids, in accordance with directive 97/23/EEC.

Operating curve

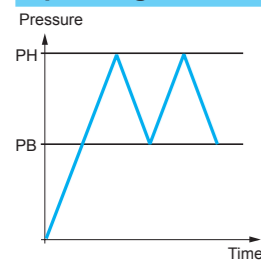

— Adjustable value

Other versions Pressure switches with alternative tapped cable entries: NPT, etc. Please consult our Customer Care Centre.

Pressure switches OsiSense ADW

Piston operated, with Quad-Ring piston seal

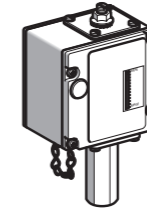

Adjustable range of switching point (PH) (Falling pressure)	9.3...69 bar (135...1000 psi)	28...210 bar (406...3045 psi)	38...340 bar (551...4930 psi)
--	----------------------------------	----------------------------------	----------------------------------

References

Switches with 1 CO single-pole contact

Electrical connection	With one tapped entry M20 x 1.5 mm for ISO cable gland	ADW5M119012	ADW6M119012	—
	With one tapped entry for n° 13 cable gland	ADW5M129012	ADW6M129012	ADW7S1M129012

Weight (kg)	1.880
-------------	-------

Switches with 2 CO single-pole contacts

Electrical connection	With one tapped entry for n° 13 cable gland	ADW25M129012	ADW26M129012	—
-----------------------	--	--------------	--------------	---

Weight (kg)	1.880
-------------	-------

Complementary characteristics not shown under general characteristics (page 75)

Possible differential (subtract from PH to give PB)	1 CO switches	Min./max. at low setting	4.8/6.9 bar (69.6/100 psi)	14/21 bar (203/304.5 psi)	19/25 bar (275.5/362.5 psi)
		Min./max. at high setting	8.6/10 bar (124.7/145 psi)	28/34 bar (406/493 psi)	38/45 bar (551/652.5 psi)
	2 CO switches	Min./max. at low setting	6.2/7.9 bar (89.9/114.6 psi)	17/24 bar (246.5/348 psi)	22/28 bar (319/406 psi)
		Min./max. at high setting	10/12 bar (145/174 psi)	34/39 bar (493/565.5 psi)	44/50 bar (638/725 psi)

Maximum permissible pressure	690 bar (10,000 psi)
------------------------------	----------------------

Fluids controlled	Oils and other fluids, from -25°C to +120°C (1) (2)
-------------------	---

Mechanical life	1 x 10 ⁶ operating cycles (average value, depending on application)
-----------------	--

Cable entry, screw terminals	ADW●M119012	1 tapped entry M20 x 1.5 mm for ISO cable gland. Clamping capacity 7 to 13 mm
	ADW●M129012, ADW2●●M129012	1 tapped entry for n° 13 cable gland, conforming to NF C 68-300 (DIN Pg 13.5). Clamping capacity 9 to 13 mm

- (1) See "Component materials of units in contact with the fluid", page 75.
- (2) Only for control of group 2 fluids, in accordance with directive 97/23/EEC.

Operating curve

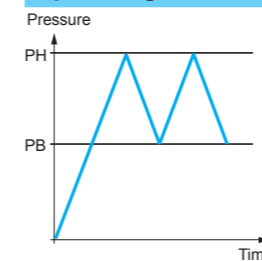

— Adjustable value

Other versions Pressure switches with alternative tapped cable entries: NPT, etc. Please consult our Customer Care Centre.

ACW3, ACW4, ACW23 and ACW24

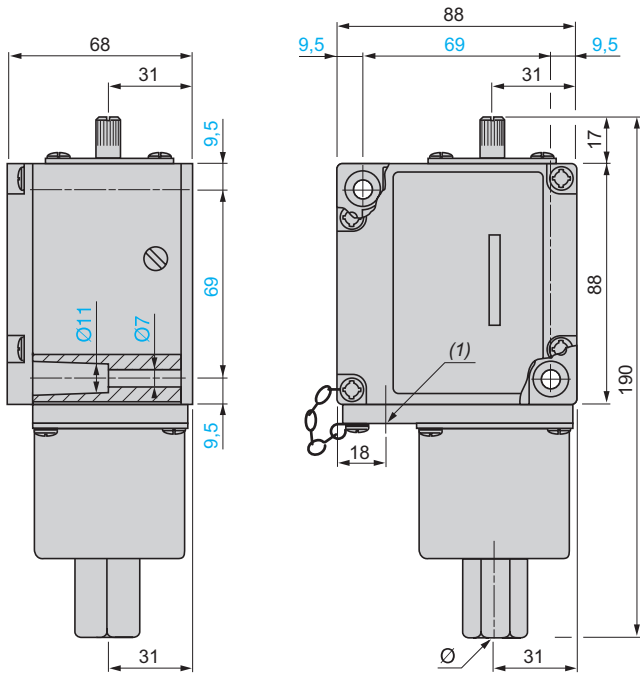

(1) Tapped entry for n° 13 or ISO M20 cable gland, depending on model
Ø: G 1/4 (female)

ACW1, ACW5, ACW8, ACW9, ACW21, ACW25, ACW28 and ACW29

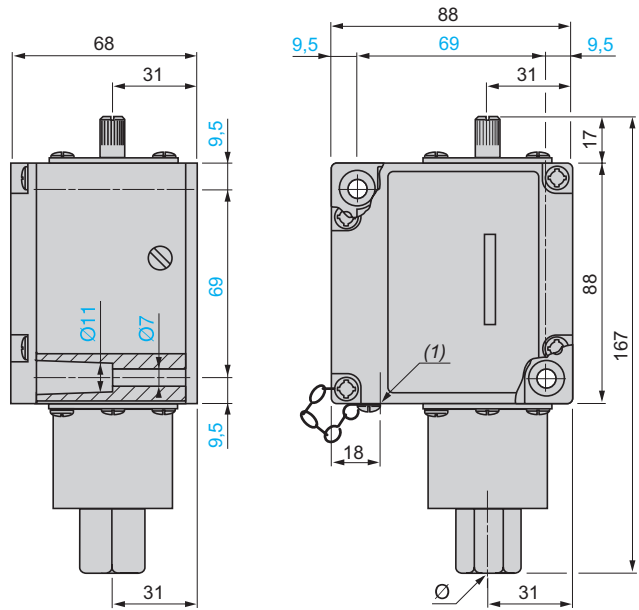

(1) Tapped entry for n° 13 or ISO M20 cable gland, depending on model
Ø: G 1/4 (female)

ACW2 and ACW22

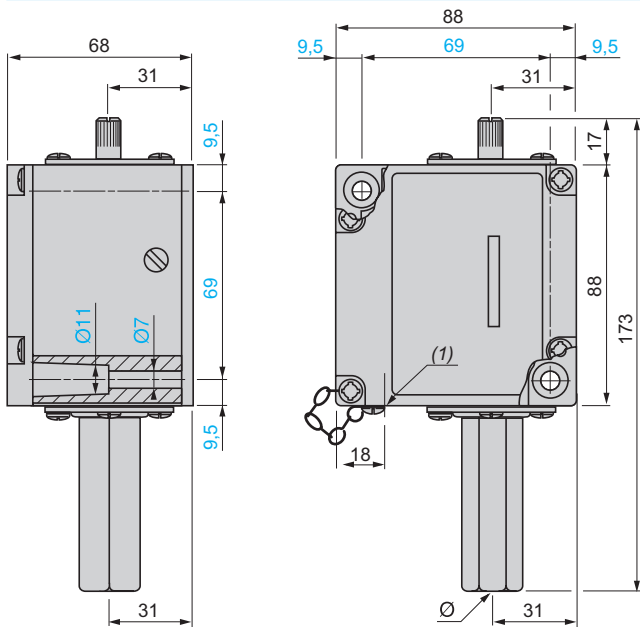

(1) Tapped entry for n° 13 or ISO M20 cable gland, depending on model
Ø: G 1/4 (female)

ACW6, ACW7, ACW10, ACW26, ACW27 and ACW20

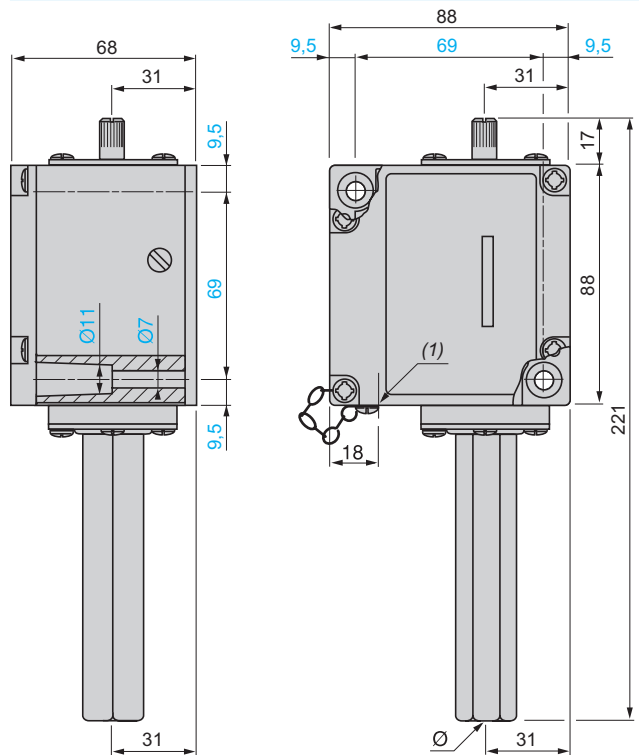

(1) Tapped entry for n° 13 or ISO M20 cable gland, depending on model
Ø: G 1/4 (female)

Electromechanical pressure switches

OsiSense XM

For control circuits, OsiSense ADW

ADW3, ADW4, ADW7, ADW23, ADW24 and ADW27

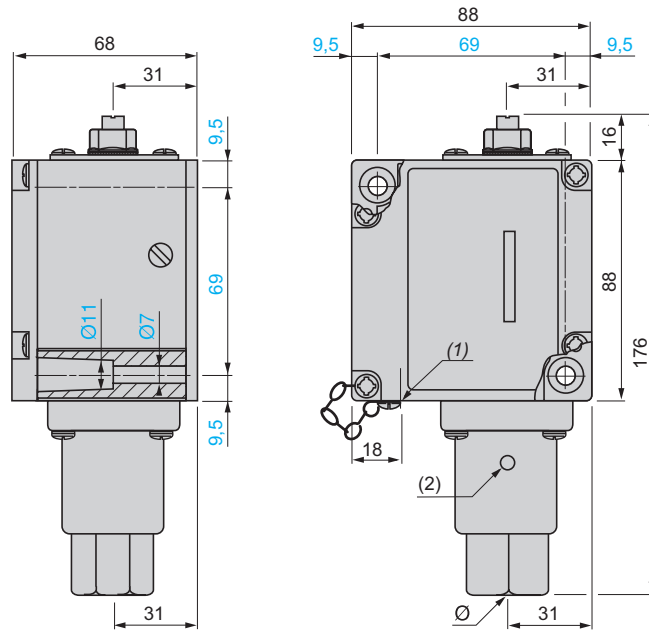

(1) Tapped entry for n° 13 or ISO M20 cable gland, depending on model

(2) Drainage hole, tapped G 1/8 (female)

Ø: G 3/8 (female)

ADW5, ADW6, ADW7S1, ADW25 and ADW26

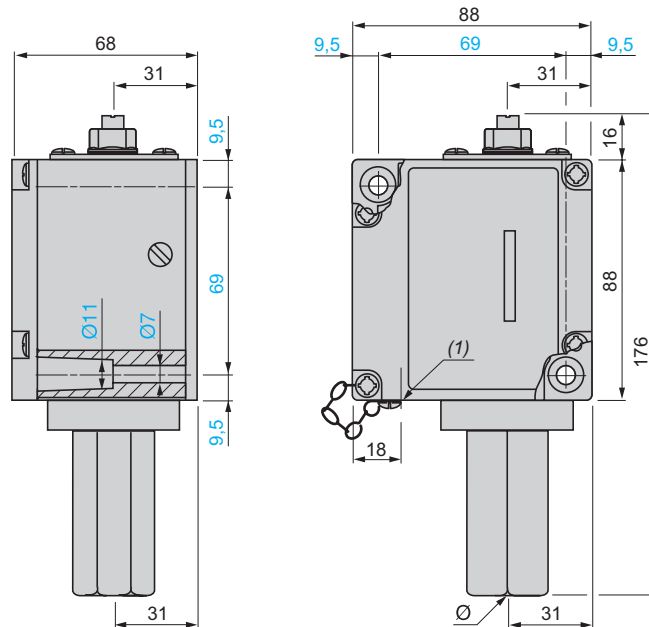

(1) Tapped entry for n° 13 or ISO M20 cable gland, depending on model

Ø: G 3/8 (female)

Presentation

Pressure switches OsiSense XM and XMA are switches for control circuits, with an adjustable differential.

They are used to control the pressure of water and air, up to 25 bar.

Equipment fitted to the various models

Location of setting screw

Pressure switches OsiSense XM have an internal setting screw that is only accessible after removing the cover.

Pressure switches OsiSense XMA have an external setting screw that is accessible without removing the cover.

Case

Pressure switches OsiSense XM have a black opaque case.

Pressure switches OsiSense XMA can have a transparent case or a black opaque case.

Setting

When setting pressure switches XM or XMA, adjust the switching point on rising pressure (PH) first and then the switching point on falling pressure (PB).

Switching point on rising pressure

The switching point on rising pressure (PH) is set by adjusting screw-nut **1**.

Switching point on falling pressure

The switching point on falling pressure (PB) is set by adjusting screw-nut **2**.

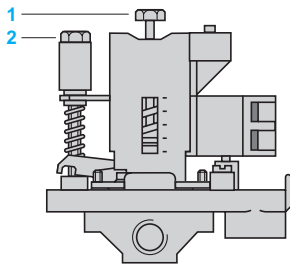

Environment characteristics		
Conformity to standards		CE, IEC/EN 60947-5-1
Product certifications		UL, CSA, CCC, EAC
Protective treatment		"TC"
Ambient air temperature	For operation	°C - 25...+ 70 for 6 and 25 bar versions - 25...+ 55 for 12 bar version
	For storage	- 40...+ 70
Fluids controlled	°C	Air, fresh water, sea water: 0...+ 70°C for 6 and 25 bar versions 0...+ 55°C for 12 bar version
Materials		Case: polycarbonate impregnated with Lexan 500R fibreglass (black opaque cover) or polycarbonate impregnated with Lexan 123 fibreglass (transparent cover) Component materials in contact with fluid: chromated zinc alloy (fluid entry), canvas covered nitrile (diaphragm)
Operating position		All positions
Electric shock protection		Class I conforming to IEC 536
Degree of protection		IP 54 conforming to IEC/EN 60529
Operating rate	Op. cycles/h	600
Repeat accuracy		< 3.5%
Fluid connection		G 1/4 or 4 x G 1/4 (BSP female) conforming to NF E 03-005, ISO 228
Electrical connection		Terminals 2 tapped entries for n° 13 (DIN Pg 13.5) cable gland
Contact block characteristics		
Rated operational characteristics		~ AC-15, B300 (Ue = 240 V, Ie = 1.5 A; Ue = 120 V, Ie = 3 A) = DC-13, R300 (Ue = 250 V, Ie = 0.1 A)
Rated insulation voltage	V	Ui = 500 conforming to IEC/EN 60947-1
Rated impulse withstand voltage	kV	U imp = 6 conforming to IEC/EN 60947-1
Type of contacts		1 CO single-pole contact, snap action
Terminal referencing		Conforming to CENELEC EN 50013
Short-circuit protection		10 A cartridge fuse type gG (gl)
Connection		Screw clamp terminals Minimum clamping capacity: 1 x 1 mm ² Maximum clamping capacity: 2 x 2.5 mm ²
Electrical durability		AC supply 50/60Hz, Ith = 10 A Inductive circuit, utilisation category AC-15, 3 A/240 V: 1 million operating cycles

Electromechanical pressure switches

OsiSense XMX for control circuits

Sizes 6 to 25 bar (87 to 362.5 psi)

Adjustable differential, for regulation between 2 thresholds

Switches with 1 CO single-pole contact

Pressure switches OsiSense XMX (internal setting screw)

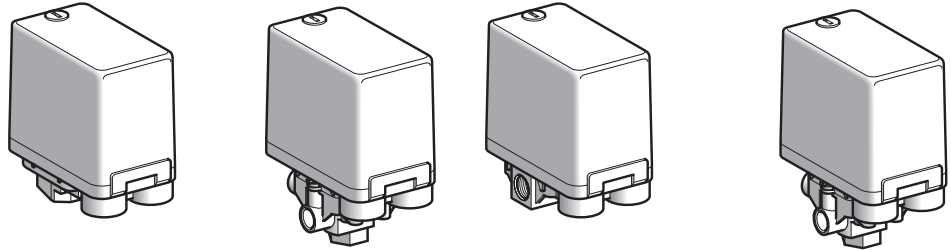

Adjustable range of switching point (PH) (Rising pressure)	1...6 bar (14.5...87 psi)	1.3...12 bar (18.85...174 psi)	3.5...25 bar (50.75...362.5 psi)	1...6 bar (14.5...87 psi)	1.3...12 bar (18.85...174 psi)	3.5...25 bar (50.75...362.5 psi)
Fluid connection	G 1/4 (female)			4 x G 1/4 (female)		

References

Switches with black opaque cover

Fluids controlled	Air, fresh water, sea water (1)	XMXA06L2135	XMXA12L2135	XMXA25L2135	XMXA06L2435	XMXA12L2435	XMXA25L2435
Weight (kg)		0.430		0.650	0.430		0.650

Complementary characteristics not shown under general characteristics (page 83)

Possible differential (subtract from PH to give PB)	Min. at low setting	0.8 bar (11.6 psi)	1 bar (14.5 psi)	3.4 bar (49.3 psi)	0.8 bar (11.6 psi)	1 bar (14.5 psi)	3.4 bar (49.3 psi)
	Min. at high setting	1.2 bar (17.4 psi)	1.7 bar (24.6 psi)	4.5 bar (65.2 psi)	1.2 bar (17.4 psi)	1.7 bar (24.6 psi)	4.5 bar (65.2 psi)
	Max. at high setting	4.2 bar (60.9 psi)	8.4 bar (121.8 psi)	20 bar (290 psi)	4.2 bar (60.9 psi)	8.4 bar (121.8 psi)	20 bar (290 psi)
Maximum permissible pressure	Per cycle	7.5 bar (108.7 psi)	15 bar (217.5 psi)	31.25 bar (453.1 psi)	7.5 bar (108.7 psi)	15 bar (217.5 psi)	31.25 bar (453.1 psi)
	Accidental	13.5 bar (195.7 psi)	27 bar (391.5 psi)	56.25 bar (815.6 psi)	13.5 bar (195.7 psi)	27 bar (391.5 psi)	56.25 bar (815.6 psi)
Destruction pressure		30 bar (435 psi)		100 bar (1450 psi)	30 bar (435 psi)		100 bar (1450 psi)
Mechanical life		1 x 10 ⁶ operating cycles					
Cable entry		2 entries tapped for n° 13 cable gland, conforming to NF C 68-300 (DIN Pg 13.5)					
Pressure switch type		Diaphragm					

(1) Component materials of units in contact with the fluid, see page 83.

Operating curves

XMXA06●●●●●

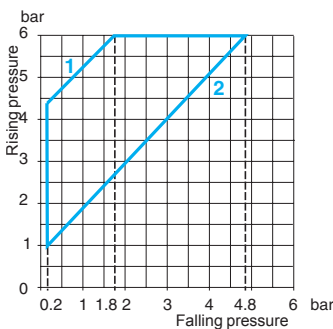

XMXA12●●●●●

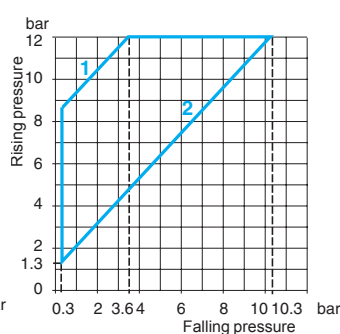

XMXA25●●●●●

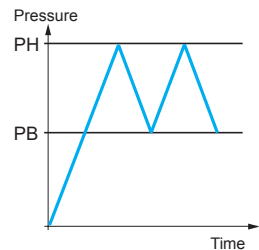
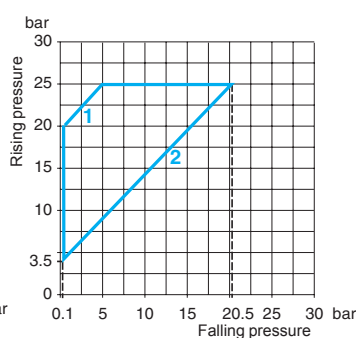

— Adjustable value

- 1 Maximum differential
- 2 Minimum differential

- 1 Maximum differential
- 2 Minimum differential

- 1 Maximum differential
- 2 Minimum differential

Connections



Other versions

Pressure switches with alternative tapped cable entries: ISO, NPT, etc. Please consult our Customer Care Centre.

Electromechanical pressure switches

OsiSense XMA for control circuits

Sizes 6 to 25 bar (87 to 362.5 psi)

Adjustable differential, for regulation between 2 thresholds

Switches with 1 CO single-pole contact

Pressure switches OsiSense XMA (external setting screw)

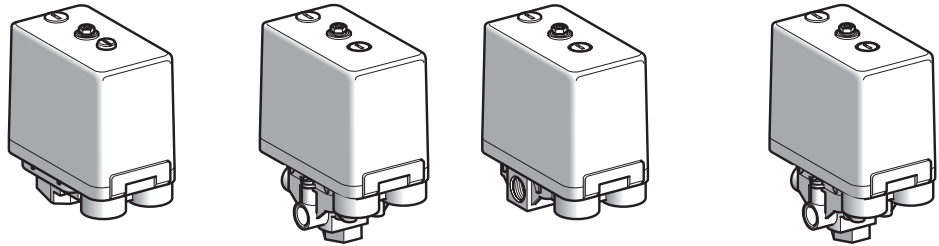

Adjustable range of switching point (PH) (Rising pressure)	1...6 bar (14.5...87 psi)	1.3...12 bar (18.85...174 psi)	3.5...25 bar (50.75...362.5 psi)	1...6 bar (14.5...87 psi)	1.3...12 bar (18.85...174 psi)	3.5...25 bar (50.75...362.5 psi)
Fluid connection	G 1/4 (female)			4 x G 1/4 (female)		

References

Switches with black opaque cover

Fluids controlled	Air, fresh water, sea water (1)	XMAH06L2135	XMAH12L2135	XMAH25L2135	XMAH06L2435	XMAH12L2435	XMAH25L2435
-------------------	------------------------------------	-------------	-------------	-------------	-------------	-------------	-------------

Switches with transparent cover

Fluids controlled	Air, fresh water, sea water (1)	XMAV06L2135	XMAV12L2135	XMAV25L2135	XMAV06L2435	XMAV12L2435	XMAV25L2435
-------------------	------------------------------------	-------------	-------------	-------------	-------------	-------------	-------------

Weight (kg)	0.430		0.650	0.430			0.650
-------------	-------	--	-------	-------	--	--	-------

Complementary characteristics not shown under general characteristics (page 83)

Possible differential (subtract from PH to give PB)	Min. at low setting	0.8 bar (11.6 psi)	1 bar (14.5 psi)	3.4 bar (49.3 psi)	0.8 bar (11.6 psi)	1 bar (14.5 psi)	3.4 bar (49.3 psi)
	Min. at high setting	1.2 bar (17.4 psi)	1.7 bar (24.6 psi)	4.5 bar (65.2 psi)	1.2 bar (17.4 psi)	1.7 bar (24.6 psi)	4.5 bar (65.2 psi)
	Max. at high setting	4.2 bar (60.9 psi)	8.4 bar (121.8 psi)	20 bar (290 psi)	4.2 bar (60.9 psi)	8.4 bar (121.8 psi)	20 bar (290 psi)
Maximum permissible pressure	Per cycle	7.5 bar (108.7 psi)	15 bar (217.5 psi)	31.25 bar (453.1 psi)	7.5 bar (108.7 psi)	15 bar (217.5 psi)	31.25 bar (453.1 psi)
	Accidental	13.5 bar (195.7 psi)	27 bar (391.5 psi)	56.25 bar (815.6 psi)	13.5 bar (195.7 psi)	27 bar (391.5 psi)	56.25 bar (815.6 psi)
Destruction pressure		30 bar (435 psi)		100 bar (1450 psi)	30 bar (435 psi)		100 bar (1450 psi)
Mechanical life		1 x 10 ⁶ operating cycles					
Cable entry		2 entries tapped for n° 13 cable gland, conforming to NF C 68-300 (DIN Pg 13.5)					
Pressure switch type		Diaphragm					

(1) Component materials of units in contact with the fluid, see page 83.

Operating curves

XMA#06#

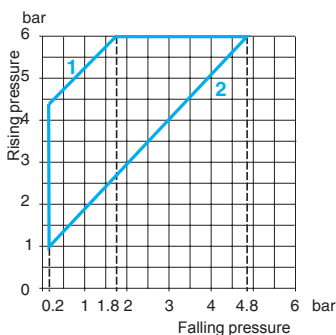

XMA#12#

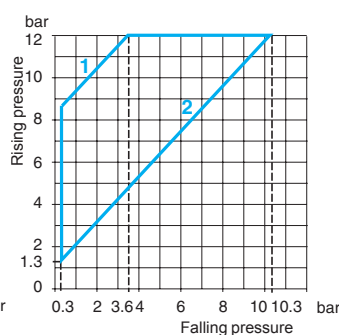

XMA#25#

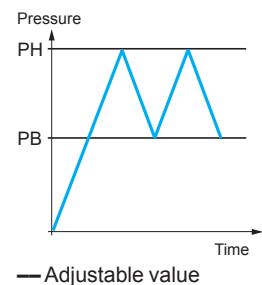
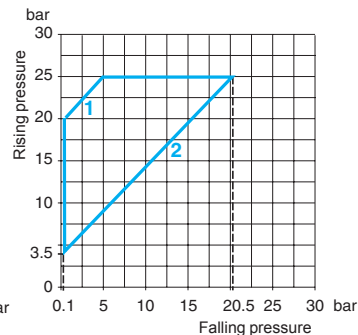

- 1 Maximum differential
- 2 Minimum differential

- 1 Maximum differential
- 2 Minimum differential

- 1 Maximum differential
- 2 Minimum differential

Connections



Other versions

Pressure switches with alternative tapped cable entries: ISO, NPT, etc. Please consult our Customer Care Centre.

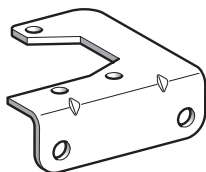

XMAZL001



XMLZL003



DE9PM1201



DE9PM1202

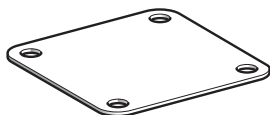

XMPZ3

References

Description	Reference	Weight kg
Fixing bracket	XMAZL001	0.035

Knurled adjustment knob, Ø 36 mm fits over adjustment screws to facilitate setting	XMLZL003	0.010
---	----------	-------

13P cable gland With anti pull-out ring (for cable Ø 6...9 mm)	DE9PM1201	0.005
--	-----------	-------

Without anti pull-out ring (for cable Ø 6...9 mm)	DE9PM1202	0.005
---	-----------	-------

With anti pull-out ring (for cable Ø 9...12.5 mm)	DE9PM1203	0.005
---	-----------	-------

Description	For pressure switch	Reference	Weight kg
Diaphragms	Size 6 bar	XMPZ31	0.005
	Size 25 bar	XMPZ33	0.005

Dimensions

XMxA06L2135, XMxA12L2135
XMA●06L2135, XMA●12L2135

XMxA06L2435, XMxA12L2435
XMA●06L2435, XMA●12L2435

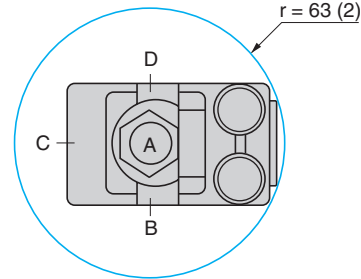
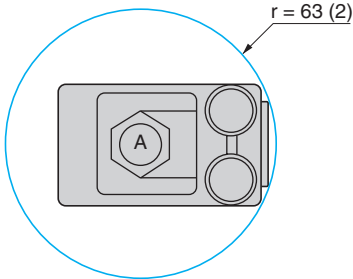
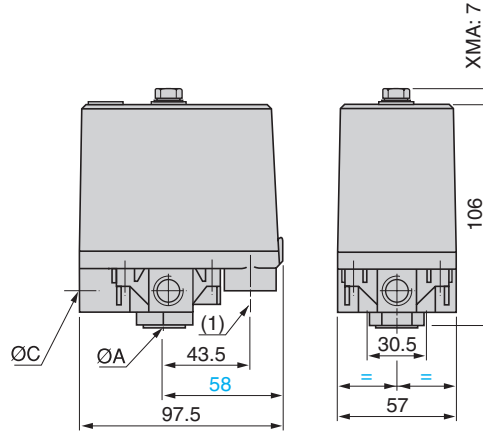
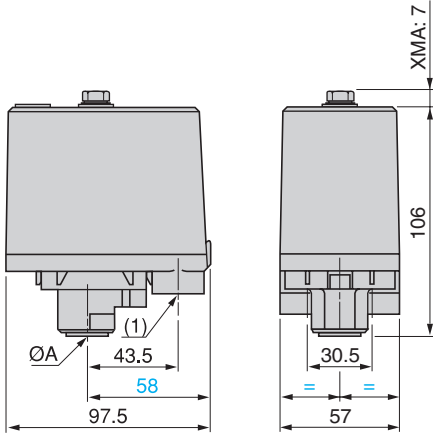

ØA = G 1/4 (female)

(1) 2 tapped entries for n° 13 cable gland

(2) Minimum clearance zone for screwing-on pressure switch at point A

XMxA25L2135, XMxA25L2435
XMA●25L2135, XMA●25L2435

ØA = ØB = ØC = ØD = G 1/4 (female)

(1) 2 tapped entries for n° 13 cable gland

(2) Minimum clearance zone for screwing-on pressure switch at point A

Fixing bracket
XMAZL001

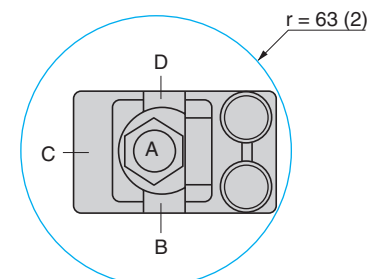
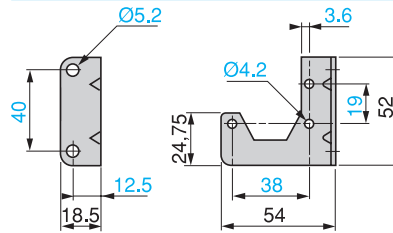
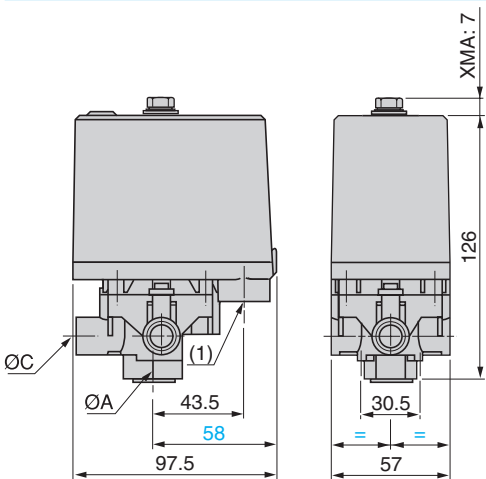

XM●25L2135: ØA only = G 1/4 (female)

XM●25L2435: ØA = ØB = ØC = ØD = G 1/4 (female)

(1) 2 tapped entries for n° 13 cable gland

(2) Minimum clearance zone for screwing-on pressure switch at point A

Electromechanical pressure switches

OsiSense XM

For power circuits, OsiSense FTG, FSG and FYG

Presentation

Pressure switches OsiSense FTG, FSG and FYG are switches for power circuits. They are used to control the pressure of water, up to 10.5 bar.

2 types of product are available:

- pressure switches OsiSense FTG with fixed differential, for detection of a single threshold,
- pressure switches OsiSense FSG and FYG with an adjustable differential, for regulation between 2 thresholds.

For specific needs, these 2 types of product can be supplied in IP 65 versions, thus ensuring a higher degree of protection. They feature 2 cable entries, fitted with cable gland, and are referenced **F•G•NE**.

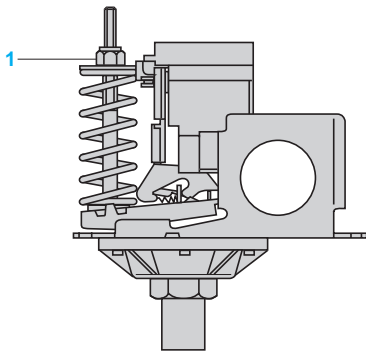

Setting

Pressure switches with fixed differential (FTG)

Only the switching point on rising pressure is adjustable.

Switching point on rising pressure

The switching point on rising pressure (PH) is set by adjusting screw-nut **1**.

Switching point on falling pressure

The switching point on falling pressure (PB) is not adjustable.

The difference between the tripping and resetting points of the contact is the natural differential of the switch (contact differential, friction, etc.).

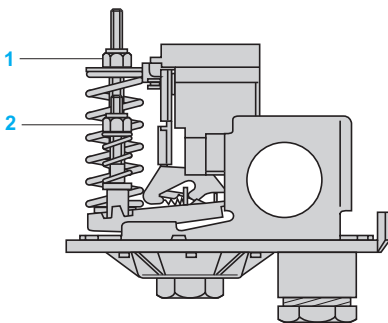

Pressure switches with adjustable differential (FSG and FYG)

When setting the pressure switch, adjust the switching point on rising pressure (PH) first and then the switching point on falling pressure (PB).

Switching point on rising pressure

The switching point on rising pressure (PH) is set by adjusting screw-nut **1**.

Switching point on falling pressure

The switching point on falling pressure (PB) is set by adjusting screw-nut **2**.

Environment characteristics					
Pressure switch type		FTG● FTG●NE	FSG● and FYG● FSG●NE and FYG●NE		
Conformity to standards		CE, IEC/EN 60730			
Protective treatment		Standard version: "TC"			
Ambient air temperature	°C	For operation: 0...+ 45. For storage: - 30...+ 80			
Fluids controlled		Fresh water, sea water (0...+ 70°C)			
Materials		Case: polystyrene, resistant to mechanical impact Component materials in contact with fluid: nylon 6/6, zinc plated steel, nitrile			
Operating position		All positions			
Electric shock protection		Class I conforming to IEC 536			
Degree of protection conforming to IEC/EN 60529	FTG●, FSG● and FYG●	IP 20			
	FTG●NE, FSG●NE and FYG●NE	IP 65			
Operating rate	Op. cycles/h	600			
Repeat accuracy		< 2%			
Fluid connection	F●G 2, FYG●2	G 1/4 (BSP female) conforming to NF E 03-005, ISO 228			
	F●G 9	R 1/4 (BSP male) conforming to NF E 03-004, ISO 7			
Electrical connection	FTG●, FSG● and FYG●	Terminals. 2 cable entries, with grommet			
	FTG●NE, FSG●NE and FYG●NE	Terminals. 2 entries incorporating 13P cable gland (DIN Pg 13.5)			
Contact block characteristics					
Rated operational characteristics		Ie = 10 A, Ue = ~ 250 V conforming to EN 60730-1			
Power ratings of controlled motors	Voltage	~ 2-pole 1-phase	~ 2-pole 3-phase	~ 2-pole 1-phase	~ 2-pole 3-phase
	110 V	0.75 kW (1 HP)	1.1 kW (1.5 HP)	0.75 kW (1 HP)	1.1 kW (1.5 HP)
	230 V	1.1 kW (1.5 HP)	1.5 kW (2 HP)	1.5 kW (2 HP)	2.2 kW (3 HP)
	400 V	1.5 kW (2 HP)	1.5 kW (2 HP)	1.5 kW (2 HP)	2.2 kW (3 HP)
Rated insulation voltage conforming to IEC/EN 60947-1	V	Ui = 500			
Rated impulse withstand voltage conforming to IEC/EN 60947-1	kV	U imp = 6			
Type of contacts		1 2-pole 2 NC (4 terminal) contact, snap action			
Short-circuit protection		20 A cartridge fuse type gG			
Connection		Screw clamp terminals. Minimum clamping capacity: 1 x 1 mm², max: 2 x 2 mm²			
Electrical durability at an operating rate of 600 operating cycles/hour	Op. cycles	40 000		100 000	

Electromechanical pressure switches

OsiSense XM

For power circuits, OsiSense FTG

Size 4.6 bar (66.7 psi), fixed differential, for detection of a single threshold. Switches with 2-pole 2 NC contact.

Degree of protection IP 20 or IP 65

Fluid connection	G 1/4 (female)	R 1/4 (male)	G 1/4 (female)	R 1/4 (male)
------------------	----------------	--------------	----------------	--------------

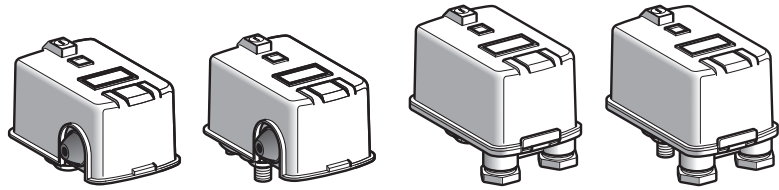

Adjustable range of switching point (PH) (Rising pressure)	1.4...4.6 bar (20.3...66.7 psi)			
Degree of protection conforming to IEC/EN 60529	IP 20		IP 65	

References

Fluids controlled	Fresh water, sea water, from 0°C to +70°C (1)	FTG2	FTG9	FTG2NE	FTG9NE
Weight (kg)	0.340				

Complementary characteristics not shown under general characteristics (page 89)

Natural differential (subtract from PH to give PB)	At low setting	1.1 bar (15.95 psi)			
	At middle setting	1.3 bar (18.85 psi)			
	At high setting	1.5 bar (21.75 psi)			
Maximum permissible pressure	Per cycle	5.75 bar (83.38 psi)			
	Accidental	8 bar (116 psi)			
Destruction pressure	20 bar (290 psi)				
Mechanical life	4 x 10 ⁵ operating cycles				
Cable entry	2 cable entries, with grommet			2 entries with 13P cable gland (DIN Pg 13.5)	
Clamping capacity	-			9 to 13 mm	
Pressure switch type	Diaphragm				

(1) Component materials of units in contact with the fluid, see page 89.

Operating curves

Connections

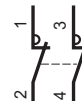
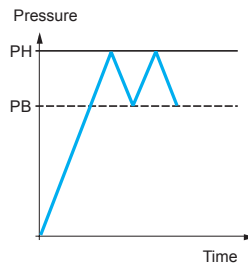
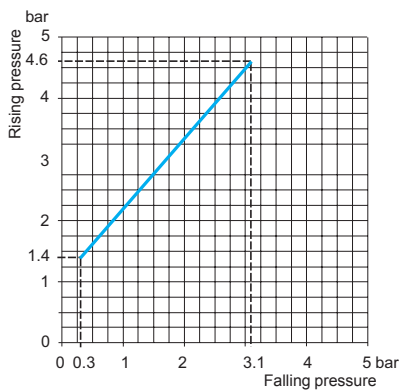

— Adjustable value
---- Non adjustable value

Electromechanical pressure switches

OsiSense XM

For power circuits, OsiSense FSG

Size 4.6 bar (66.7 psi), adjustable differential, for regulation between 2 thresholds. Switches with 2-pole 2 NC contact.

Degree protection IP 20 or IP 65

Fluid connection	G 1/4 (female)	R 1/4 (male)	G 1/4 (female)	R 1/4 (male)
------------------	----------------	--------------	----------------	--------------

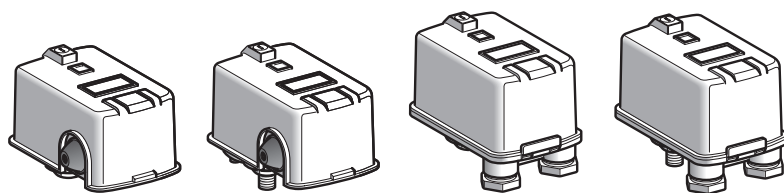

Adjustable range of switching point (PH) (Rising pressure)	1.4...4.6 bar (20.3...66.7 psi)			
---	---------------------------------	--	--	--

Degree of protection conforming to IEC/EN 60529	IP 20		IP 65	
--	-------	--	-------	--

References

Fluids controlled	Fresh water, sea water, from 0°C to +70°C (1)	FSG2	FSG9	FSG2NE (2)	FSG9NE
-------------------	---	------	------	------------	--------

Weight (kg)	0.340			
-------------	-------	--	--	--

Complementary characteristics not shown under general characteristics (page 89)

Possible differential (subtract from PH to give PB)	Max. at low setting	2.1 bar (30.45 psi)
	Max. at middle setting	2.2 bar (31.9 psi)
	Max. at high setting	2.3 bar (33.35 psi)
	Min. at low setting	1 bar (14.5 psi)
	Min. at middle setting	1.1 bar (15.95 psi)
	Min. at high setting	1.2 bar (17.4 psi)
Maximum permissible pressure	Per cycle	5.75 bar (83.38 psi)
	Accidental	8 bar (116 psi)
Destruction pressure	20 bar (290 psi)	
Mechanical life	1 x 10 ⁶ operating cycles	
Cable entry	2 cable entries, with grommet	2 entries with 13P cable gland (DIN Pg 13.5)
Clamping capacity	9 to 13 mm	
Pressure switch type	Diaphragm	

(1) Component materials of units in contact with the fluid, see page 89.

(2) Variant: for a G 3/8 female fluid entry that pivots throughout 360°, select the **FSG2NEG**.

Operating curves

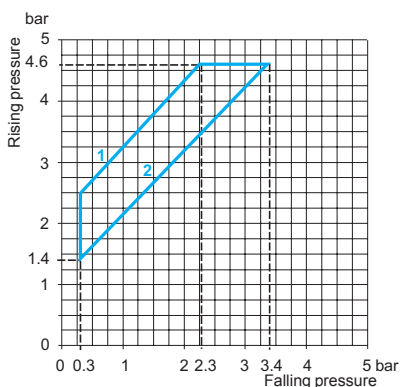

- 1 Maximum differential
- 2 Minimum differential

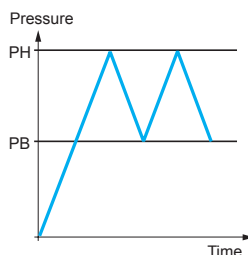

— Adjustable value



Electromechanical pressure switches

OsiSense XM

For power circuits, OsiSense FYG

Sizes 7 and 10.5 bar (101.5 and 152.3 psi), adjustable differential, for regulation between 2 thresholds. Switches with 2-pole 2 NC contact. Degree of protection IP 20 or IP 65

Fluid connection	G 1/4 (female)
-------------------------	-----------------------

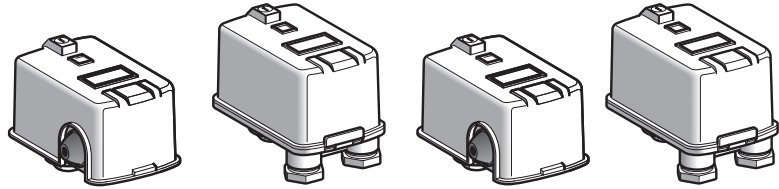

Adjustable range of switching point (PH) (Rising pressure)	2.8...7 bar (40.6...101.5 psi)		5.6...10.5 bar (81.2...152.3 psi)	
Degree of protection conforming to EN/IEC 60529	IP 20	IP 65	IP 20	IP 65

References

Fluids controlled	Fresh water, sea water, from 0°C to +70°C (1)	FYG22 (2)	FYG22NE	FYG32 (3)	FYG32NE
Weight (kg)	0.340				

Complementary characteristics not shown under general characteristics (page 89)

Possible differential (subtract from PH to give PB)	Max. at low setting	2.3 bar (33.35 psi)	3 bar (43.5 psi)
	Max. at middle setting	2.5 bar (36.25 psi)	3.2 bar (46.4 psi)
	Max. at high setting	2.7 bar (39.15 psi)	3.4 bar (49.3 psi)
	Min. at low setting	1.2 bar (17.4 psi)	1.9 bar (27.55 psi)
	Min. at middle setting	1.4 bar (20.3 psi)	2.1 bar (30.45 psi)
	Min. at high setting	1.6 bar (23.2 psi)	2.3 bar (33.35 psi)
Maximum permissible pressure	Per cycle	8.75 bar (126.9 psi)	13 bar (188.5 psi)
	Accidental	15 bar (217.5 psi)	15 bar (217.5 psi)
Destruction pressure		20 bar (290 psi)	20 bar (290 psi)
Mechanical life	1 x 10 ⁶ operating cycles		
Cable entry	2 cable entries, with grommet		
Pressure switch type	Diaphragm		

(1) Component materials of units in contact with the fluid, see page 89.

(2) Variant: for a 2.8 to 7 bar, IP 20, pressure switch with R 1/4 (male) fluid entry, select the **FYG29**.

(3) Variant: for a 5.6 to 10.5 bar, IP 20, pressure switch with R 1/4 (male) fluid entry, select the **FYG39**.

Operating curves

Connections

FYG22

FYG32

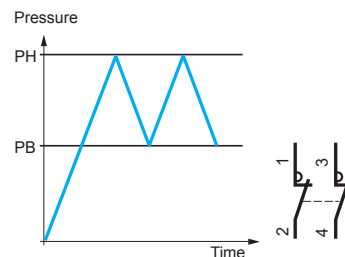
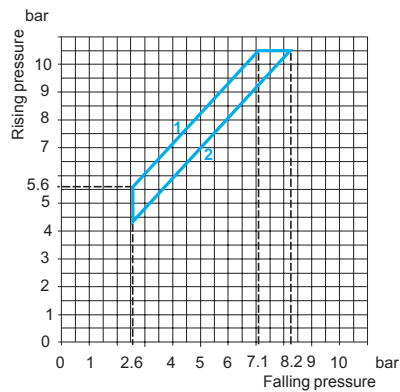
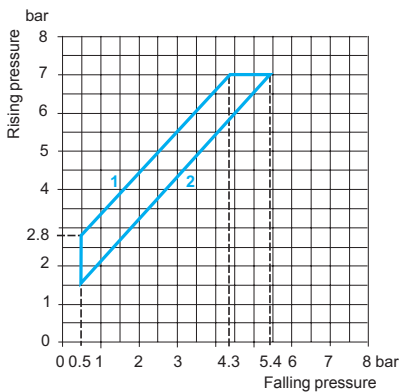

- 1 Maximum differential
- 2 Minimum differential

- 1 Maximum differential
- 2 Minimum differential

— Adjustable value

Dimensions

FTG2, FSG2

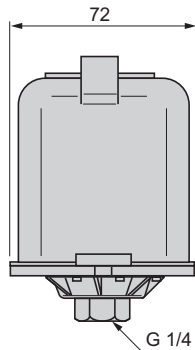
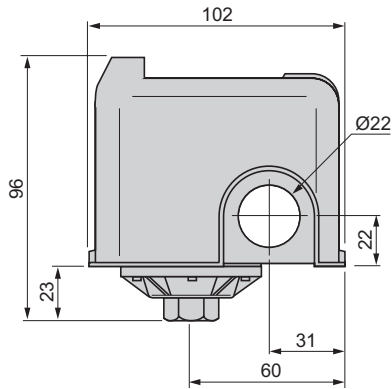

FTG2NE, FSG2NE

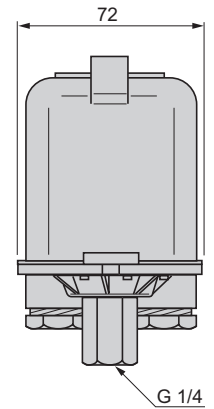
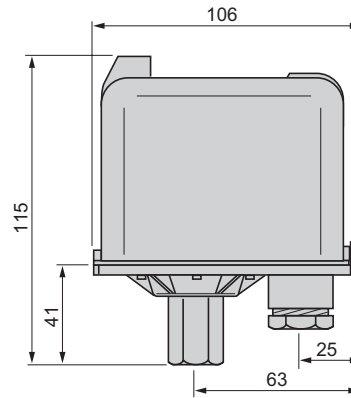

FTG9, FSG9

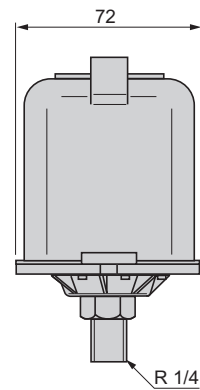
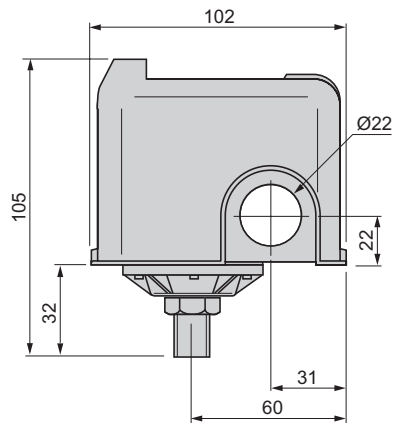

FTG9NE, FSG9NE

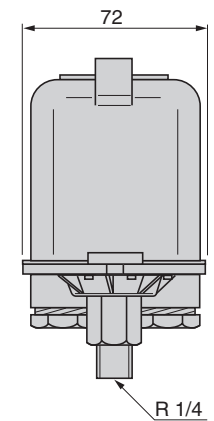
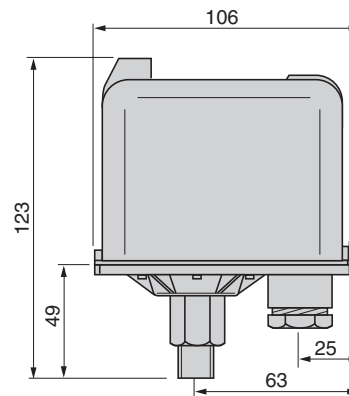

FYG22, FYG32

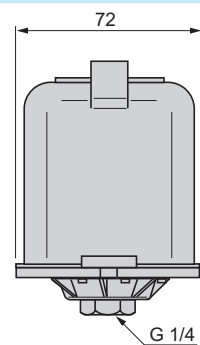
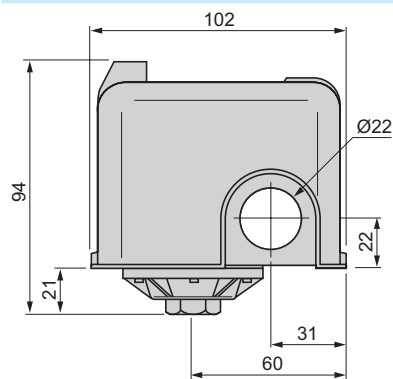

FYG22NE, FYG32NE

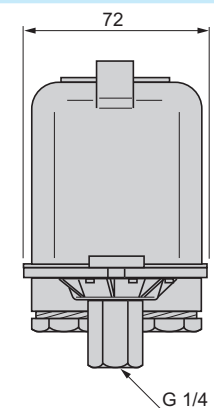
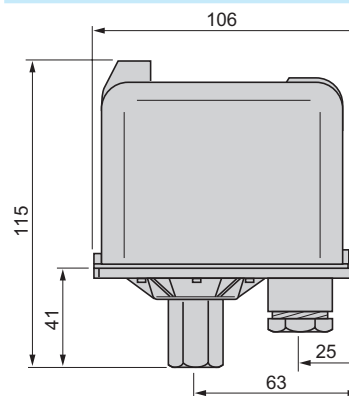

Electromechanical pressure switches

OsiSense XM

For power circuits, OsiSense XMP

Presentation

Pressure switches OsiSense XMP are switches for power circuits (direct switching), with an adjustable differential.

They are used to control the pressure of water and air, up to 25 bar.

Equipment fitted to the various models

Case

Pressure switches OsiSense XMP, depending on the model, include:

- 3 types of case:
 - bare case,
 - case with On/Off knob (black): used as a switch for starting and stopping the installation,
 - case with reset knob (yellow): necessary when the safety requirements of the system include tripping in the event of overpressure. Resetting is not automatic on return to normal pressure, and it can only be achieved by manually turning the "Reset" knob.

- 2 degrees of protection:
 - IP 54,
 - IP 65.

Decompression valve

Depending on the model, 2 types of decompression valve can be fitted to pressure switches OsiSense XMP:

- Straight, instant connection, decompression valve (connection by Ø 6 mm plastic tube).
- Straight, olive connection, decompression valve (connection by Ø 6 mm plastic or metal tube).

Setting

When setting XMP pressure switches, adjust the switching point on rising pressure (PH) first and then the switching point on falling pressure (PB).

Switching point on rising pressure

The switching point on rising pressure (PH) is set by adjusting the screw-nut or knurled knob **1**.

Tighten either the nut or knurled knob **1** to increase the high point switching value.

Switching point on falling pressure

The switching point on falling pressure is set by adjusting screw-nut **2**.

Tighten nut **2** to reduce the low point switching value (increase in differential).

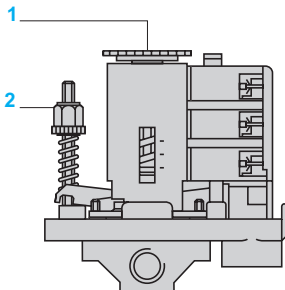

Environment characteristics																	
Conformity to standards		CE, IEC/EN 60947-4-1															
Product certifications		EAC															
Ambient air temperature	°C	For operation: - 25...+ 70 For storage: - 40...+ 70															
Fluids controlled		Air, fresh water, sea water (0...+ 70°C)															
Materials		Case: polyamide impregnated with fibreglass Component materials in contact with fluid: chromated zinc alloy (fluid entry), canvas covered nitrile (diaphragm)															
Operating position		All positions															
Vibration resistance		3 gn (10...500 Hz) conforming to IEC 60068-2-6															
Shock resistance		50 gn, conforming to IEC 60068-2-27															
Electric shock protection		Class I conforming to IEC 60536															
Degree of protection		IP 54 conforming to IEC/EN 60529 or IP 65 for universal model															
Operating rate	Op. cycles/h	≤ 600															
Repeat accuracy		< 3.5%															
Fluid connection		G 1/4, 4 x G 1/4 or G 3/8 (BSP female) conforming to NF E 03-005, ISO 228															
Electrical connection		2 tapped entries for n° 13 (DIN Pg 13.5) cable gland															
Contact block characteristics																	
Rated insulation voltage	V	Ui = 500 conforming to IEC/EN 60947-1															
Rated impulse withstand voltage	V	U imp = 6 kV conforming to IEC/EN 60947-1															
Type of contacts		One 2-pole 2 NC or 3-pole 3 NC contact, snap action															
Resistance across terminals	mΩ	≤ 25 conforming to NF C 93-050 method A or IEC 255-7 category 3															
Terminal referencing		Conforming to CENELEC EN 50013															
Short-circuit protection		Cartridge fuse type Am															
Connection		Screw clamp terminals. Minimum clamping capacity: 2 x 4 mm ²															
Electrical durability		<table border="1"> <thead> <tr> <th>Power</th> <th colspan="2">Number of operating cycles</th> </tr> <tr> <th>kW</th> <th>~ 400 V, 3-phase</th> <th>~ 230 V, 3-phase</th> </tr> </thead> <tbody> <tr> <td>1.5</td> <td>1 000 000</td> <td>600 000</td> </tr> <tr> <td>2.2</td> <td>700 000</td> <td>–</td> </tr> <tr> <td>3</td> <td>500 000</td> <td>–</td> </tr> </tbody> </table>	Power	Number of operating cycles		kW	~ 400 V, 3-phase	~ 230 V, 3-phase	1.5	1 000 000	600 000	2.2	700 000	–	3	500 000	–
Power	Number of operating cycles																
kW	~ 400 V, 3-phase	~ 230 V, 3-phase															
1.5	1 000 000	600 000															
2.2	700 000	–															
3	500 000	–															
Operating rate: 600 operating cycles/hour Load factor: 0.4																	

Electromechanical pressure switches

OsiSense XMP, IP 54

Size 6 bar (87 psi)

Adjustable differential, for regulation between 2 thresholds

Switches with 2-pole 2 NC or 3-pole 3 NC contact

Fluid connection | G 1/4 (female)

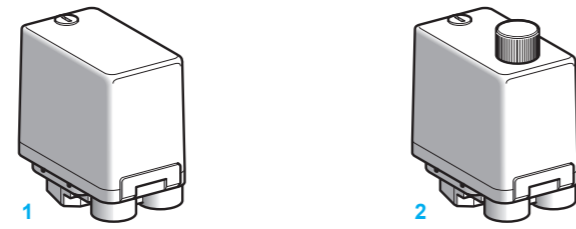

Adjustable range of switching point (PH) (Rising pressure)	1...6 bar (14.5...87 psi)	
Type of contact	2-pole 2 NC	3-pole 3 NC

References (1)

Switches without decompression valve

Bare case 1	XMPA06B2131	XMPA06C2131
Case with reset knob 2	XMPB06B2131	-
Case with On/Off knob 2	XMPC06B2131	XMPC06C2131
Weight (kg)	0.430	

Switches with straight decompression valve, instant connection

Bare case 1	XMPD06B2131	XMPD06C2131
Case with On/Off knob 2	XMPE06B2131	XMPE06C2131
Weight (kg)	0.450	

Complementary characteristics not shown under general characteristics (page 95)

Possible differential (subtract from PH to give PB)	Min. at low setting	0.8 bar (11.6 psi)
	Min. at high setting	1.2 bar (17.4 psi)
	Max. at high setting	4.2 bar (60.9 psi)
Destruction pressure	30 bar (435 psi)	
Mechanical life	1 million operating cycles	
Cable entry	2 entries tapped for n° 13 cable gland, conforming to NF C 68-300 (DIN Pg 13.5)	
Pressure switch type	Diaphragm	

(1) References for individually packaged switches. Also available packaged in lots of 10.
To order, add the letter C to the reference selected from above. Example: reference for lot of 10 pressure switches XMPA06B2131 in one package becomes XMPA06B2131C.

Operating curves

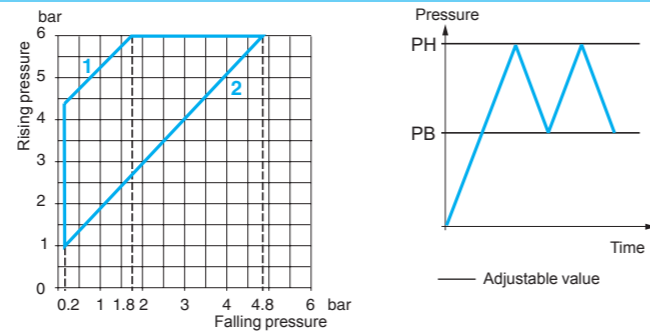

- 1 Maximum differential
- 2 Minimum differential

4 x G 1/4 (female) | G 3/8 (female)

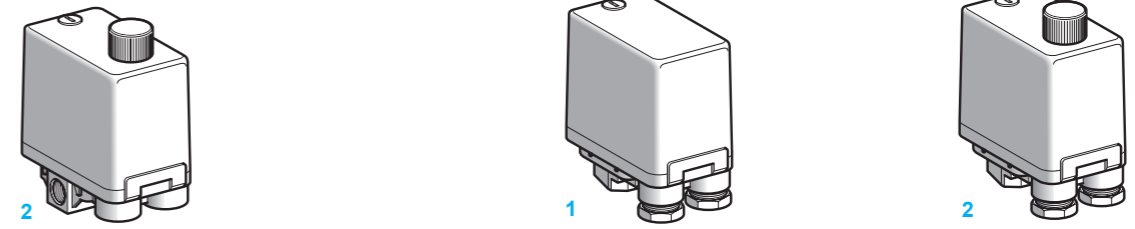

1...6 bar (14.5...87 psi)		
3-pole 3 NC	2-pole 2 NC	3-pole 3 NC

References

Switches without decompression valve

-	XMPA06B2242	XMPA06C2242
-	XMPB06B2242	-
-	XMPC06B2242	XMPC06C2242
-	0.430	

Switches with straight decompression valve, instant connection

-	XMPD06B2242	XMPD06C2242
XMPE06C2431	-	XMPE06C2242
0.450		

Complementary characteristics not shown under general characteristics (page 95)

0.8 bar (11.6 psi)	
1.2 bar (17.4 psi)	
4.2 bar (60.9 psi)	
30 bar (435 psi)	
1 million operating cycles	
2 entries tapped for n° 13 cable gland, conforming to NF C 68-300 (DIN Pg 13.5)	2 entries incorporating n° 13 plastic cable gland (DIN Pg 13.5) Clamping capacity 9 to 13 mm
Diaphragm	

Other versions Pressure switches not listed above, comprising the equipment proposed for the choice of reference. Please consult our Customer Care Centre.

Terminal connections

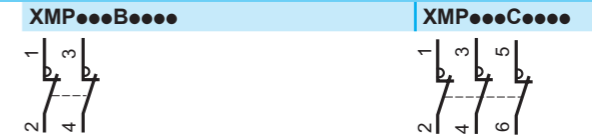

Electromechanical pressure switches

OsiSense XMP, IP 54
Size 12 bar (174 psi)
Adjustable differential, for regulation between 2 thresholds
Switches with 2-pole 2 NC or 3-pole 3 NC contact

Fluid connection **G 1/4 (female)**

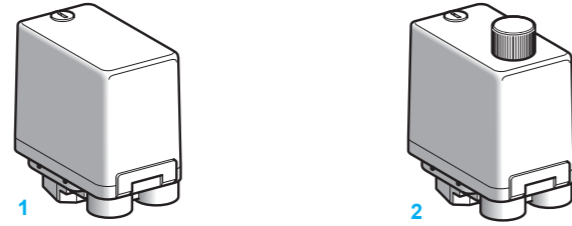

Adjustable range of switching point (PH) (Rising pressure)	1.3...12 bar (18.85...174 psi)	
Type of contact	2-pole 2 NC	3-pole 3 NC

References (1)

Switches without decompression valve

Bare case 1	XMPA12B2131	XMPA12C2131
Case with reset knob 2	XMPB12B2131	-
Case with On/Off knob 2	XMPC12B2131	XMPC12C2131

Weight (kg) 0.430

Switches with straight decompression valve, instant connection

Bare case 1	XMPD12B2131	XMPD12C2131
Case with On/Off knob 2	XMPE12B2131	XMPE12C2131

Weight (kg) 0.450

Switches with straight decompression valve, olive connection

Case with On/Off knob 2	XMPR12B2131	XMPR12C2131
-------------------------	-------------	-------------

Weight (kg) 0.450

Complementary characteristics not shown under general characteristics (page 95)

Possible differential (subtract from PH to give PB)	Min. at low setting	1 bar (14.5 psi)
	Min. at high setting	1.7 bar (24.6 psi)
	Max. at high setting	8.4 bar (121.8 psi)

Destruction pressure 30 bar (435 psi)

Mechanical life 1 million operating cycles

Cable entry 2 entries tapped for n° 13 cable gland, conforming to NF C 68-300 (DIN Pg 13.5)

Pressure switch type Diaphragm

(1) References for individually packaged switches. Also available packaged in lots of 10.
To order, add the letter **C** to the reference selected from above. Example: reference for lot of 10 pressure switches **XMPA12B2131** in one package becomes **XMPA12B2131C**.

Operating curves

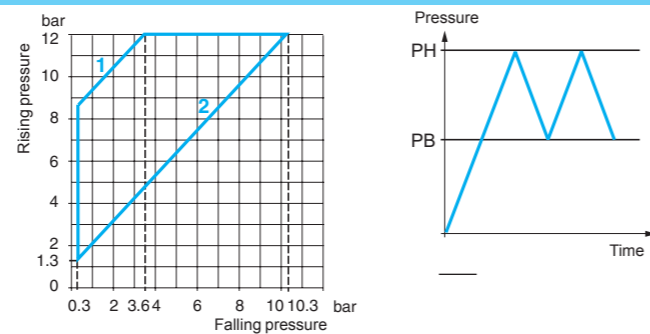

- 1 Maximum differential
- 2 Minimum differential

4 x G 1/4 (female) **G 3/8 (female)**

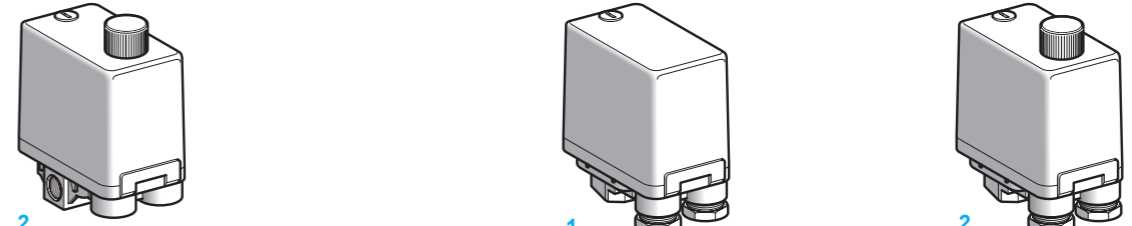

1.3...12 bar (18.85...174 psi)			
2-pole 2 NC	3-pole 3 NC	2-pole 2 NC	3-pole 3 NC

References

Switches without decompression valve

-	XMPA12B2242	XMPA12C2242
-	XMPB12B2242	-
XMPC12B2431	-	XMPC12C2242

0.430

Switches with straight decompression valve, instant connection

-	XMPD12C2431	XMPD12B2242	XMPD12C2242
XMPE12B2431	XMPE12C2431	XMPE12B2242	XMPE12C2242

0.450

Switches with straight decompression valve, olive connection

-	-	-	-
---	---	---	---

Complementary characteristics not shown under general characteristics (page 95)

1 bar (14.5 psi)
1.7 bar (24.6 psi)
8.4 bar (121.8 psi)

Destruction pressure 30 bar (435 psi)

Mechanical life 1 million operating cycles

2 entries tapped for n° 13 cable gland, conforming to NF C 68-300 (DIN Pg 13.5) | 2 entries incorporating n° 13 plastic cable gland (DIN Pg 13.5)
Clamping capacity 9 to 13 mm

Diaphragm

Other versions Pressure switches not listed above, comprising the equipment proposed for the choice of reference. Please consult our Customer Care Centre.

Terminal connections

XMP...B...

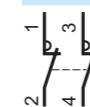

XMP...C...

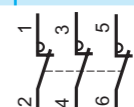

Electromechanical pressure switches

OsiSense XMP, IP 54
Size 25 bar (362.5 psi)
Adjustable differential, for regulation between 2 thresholds
Switches with 2-pole 2 NC or 3-pole 3 NC contact

Fluid connection G 1/4 (female)

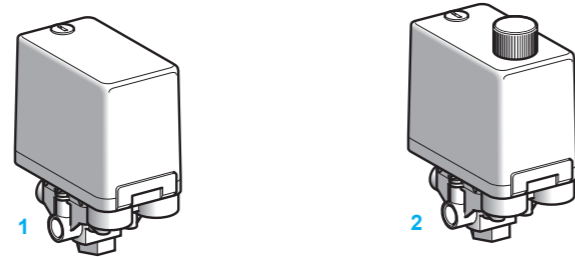

Adjustable range of switching point (PH) (Rising pressure)	3.5...25 bar (50.75...362.5 psi)
Type of contact	2-pole 2 NC

References

Switches without decompression valve

Bare case 1	XMPA25B2131
Case with reset knob 2	XMPB25B2131
Case with On/Off knob 2	XMPC25B2131
Weight (kg)	0.650

Switches with straight decompression valve, olive connection

Case with On/Off knob 2	XMPR25B2131
Weight (kg)	0.670

Complementary characteristics not shown under general characteristics (page 95)

Possible differential (subtract from PH to give PB)	Min. at low setting	3.4 bar (49.3 psi)
	Min. at high setting	4.5 bar (65.2 psi)
	Max. at high setting	20 bar (290 psi)
Destruction pressure	100 bar (1450 psi)	
Mechanical life	1 million operating cycles	
Cable entry	2 entries tapped for n° 13 cable gland, conforming to NF C 68-300 (DIN Pg 13.5)	
Pressure switch type	Diaphragm	

Operating curves

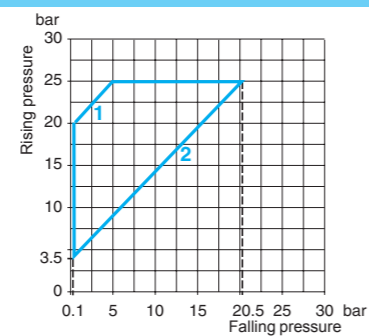

- 1 Maximum differential
- 2 Minimum differential

G 1/4 (female)



Adjustable range of switching point (PH) (Rising pressure)	3.5...25 bar (50.75...362.5 psi)
Type of contact	3-pole 3 NC

References

Switches without decompression valve

Bare case 1	XMPA25C2131
Case with reset knob 2	XMPB25C2131
Case with On/Off knob 2	XMPC25C2131
Weight (kg)	0.650

Switches with straight decompression valve, olive connection

Case with On/Off knob 2	XMPR25C2131
Weight (kg)	0.670

Complementary characteristics not shown under general characteristics (page 95)

Possible differential (subtract from PH to give PB)	Min. at low setting	3.4 bar (49.3 psi)
	Min. at high setting	4.5 bar (65.2 psi)
	Max. at high setting	20 bar (290 psi)
Destruction pressure	100 bar (1450 psi)	
Mechanical life	1 million operating cycles	
Cable entry	2 entries tapped for n° 13 cable gland, conforming to NF C 68-300 (DIN Pg 13.5)	
Pressure switch type	Diaphragm	

Other versions Pressure switches not listed above, comprising the equipment proposed for the choice of reference. Please consult our Customer Care Centre.

Terminal connections

XMP...B....

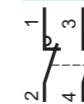

XMP...C....

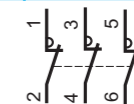

Electromechanical pressure switches

OsiSense XMP, IP 65
 Sizes 6 to 25 bar (87 to 362.5 psi)
 Adjustable differential, for regulation between 2 thresholds
 Switches with 2-pole 2 NC or 3-pole 3 NC contact

Fluid connection G 1/4 (female)

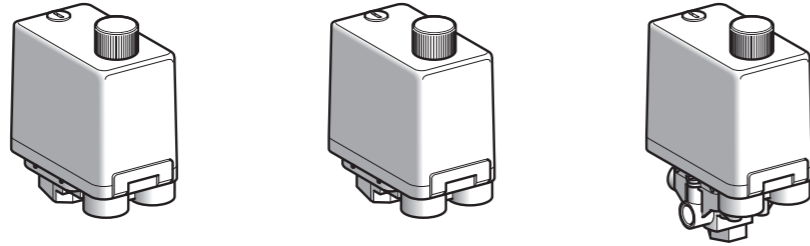

Adjustable range of switching point (PH) (Rising pressure)	1...6 bar (14.5...87 psi)		1.3...12 bar (18.85...174 psi)		3.5...25 bar (50.75...362.5 psi)	
Type of contact	2-pole 2 NC	3-pole 3 NC	2-pole 2 NC	3-pole 3 NC	2-pole 2 NC	3-pole 3 NC

References

Switches with straight decompression valve, olive connection

Case with On/Off knob	XMPR06B2133	XMPR06C2133	XMPR12B2133	XMPR12C2133	XMPR25B2133	XMPR25C2133
Weight (kg)	0.450			0.670		

Complementary characteristics not shown under general characteristics (page 95)

Possible differential (subtract from PH to give PB)	Min. at low setting	0.8 bar (11.6 psi)	1 bar (14.5 psi)	3.4 bar (49.3 psi)
	Min. at high setting	1.2 bar (17.4 psi)	1.7 bar (24.6 psi)	4.5 bar (65.2 psi)
	Max. at high setting	4.2 bar (60.9 psi)	8.4 bar (121.8 psi)	20 bar (290 psi)
Destruction pressure	30 bar (435 psi)		100 bar (1450 psi)	
Mechanical life	1 million operating cycles			
Cable entry	2 entries tapped for n° 13 cable gland, conforming to NF C 68-300 (DIN Pg 13.5)			
Adjustment of high setting point (PH)	By screw-nut			
Pressure switch type	Diaphragm			

Operating curves

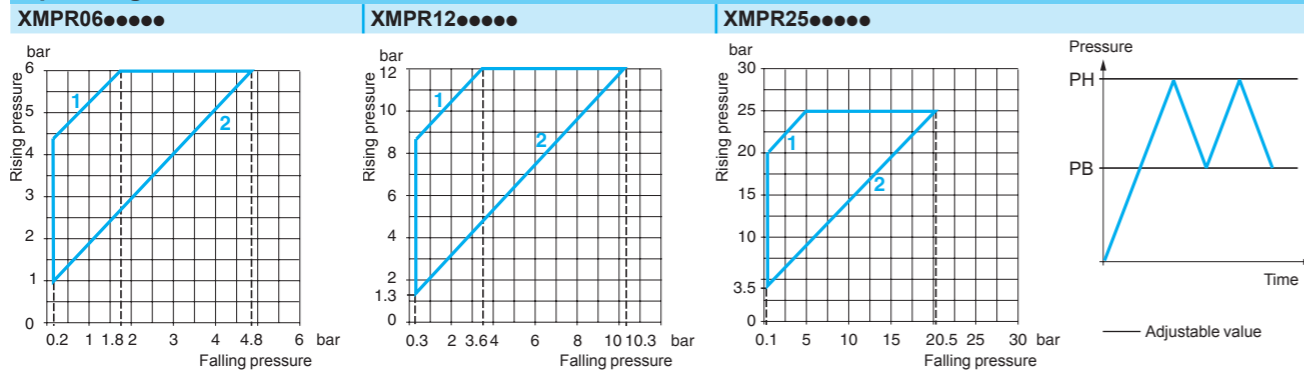

1 Maximum differential
2 Minimum differential

1 Maximum differential
2 Minimum differential

1 Maximum differential
2 Minimum differential

4 x G 1/4 (female)

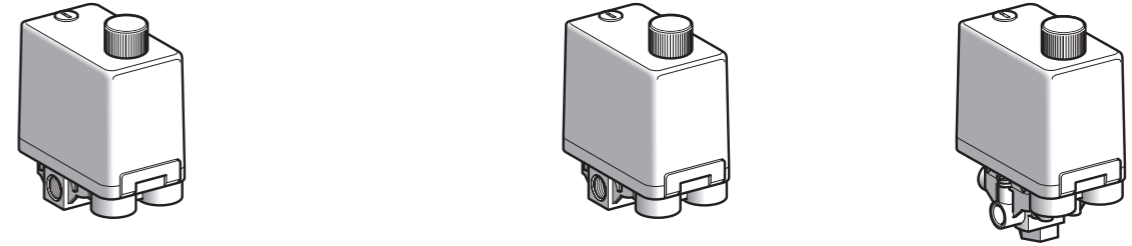

Adjustable range of switching point (PH) (Rising pressure)	1...6 bar (14.5...87 psi)		1.3...12 bar (18.85...174 psi)		3.5...25 bar (50.75...362.5 psi)	
Type of contact	2-pole 2 NC	3-pole 3 NC	2-pole 2 NC	3-pole 3 NC	2-pole 2 NC	3-pole 3 NC

References

Switches with straight decompression valve, olive connection

Case with On/Off knob	XMPR06B2433	XMPR06C2433	XMPR12B2433	XMPR12C2433	XMPR25B2433	XMPR25C2433
Weight (kg)	0.450			0.670		

Complementary characteristics not shown under general characteristics (page 95)

Possible differential (subtract from PH to give PB)	Min. at low setting	0.8 bar (11.6 psi)	1 bar (14.5 psi)	3.4 bar (49.3 psi)
	Min. at high setting	1.2 bar (17.4 psi)	1.7 bar (24.6 psi)	4.5 bar (65.2 psi)
	Max. at high setting	4.2 bar (60.9 psi)	8.4 bar (121.8 psi)	20 bar (290 psi)
Destruction pressure	30 bar (435 psi)		100 bar (1450 psi)	
Mechanical life	1 million operating cycles			
Cable entry	2 entries tapped for n° 13 cable gland, conforming to NF C 68-300 (DIN Pg 13.5)			
Adjustment of high setting point (PH)	By screw-nut			
Pressure switch type	Diaphragm			

Other versions

Pressure switches not listed above, comprising the equipment proposed for the choice of reference. Please consult our Customer Care Centre.

Terminal connections



Electromechanical pressure switches

OsiSense XM

For power circuits, OsiSense XMP

Accessories and replacement parts

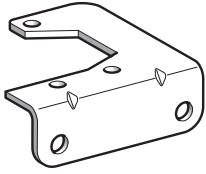

XMAZL001



XMPMDR01



DE9PM1201



DE9PM1202

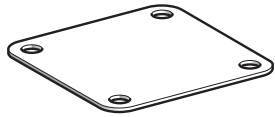

XMPZ3●

References

Description	Reference	Weight kg
Fixing bracket	XMAZL001	0.035

Knurled adjustment knob, Ø 36 mm fits over adjustment screws to facilitate setting	XMPMDR01	0.010
---	----------	-------

13P cable gland	With anti pull-out ring (for cable Ø 6...9 mm)	DE9PM1201	0.005
-----------------	---	-----------	-------

	Without anti pull-out ring (for cable Ø 6...9 mm)	DE9PM1202	0.005
--	--	-----------	-------

	With anti pull-out ring (for cable Ø 9...12.5 mm)	DE9PM1203	0.005
--	--	-----------	-------

Description	For pressure switch	Sold in lots of	Unit reference	Weight kg
Diaphragms	Size 6 bar	50	XMPZ31	0.005
	Size 25 bar	50	XMPZ33	0.005

Dimensions

XMP●06●●●●● and XMP●12●●●●●

Fluid connection G 1/4 or G 3/8 (female)
Without decompression valve

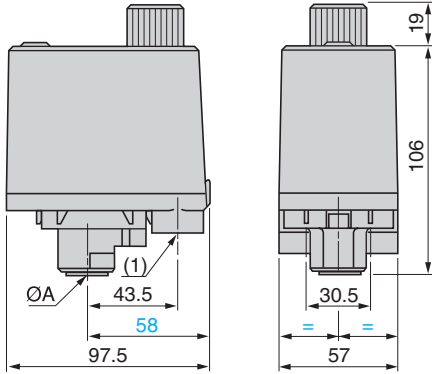

Fluid connection 4 x G 1/4 (female)
Without decompression valve

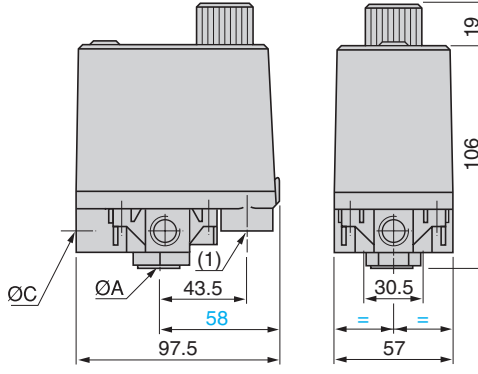

With straight, instant connection, decompression valve

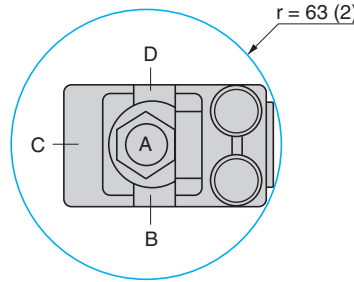
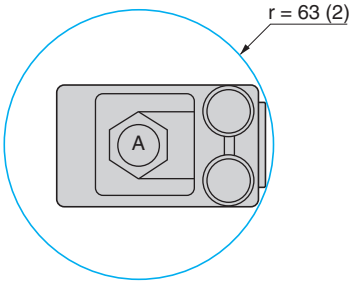
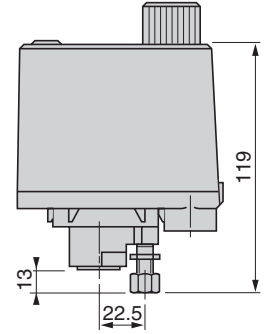

With straight, olive connection, decompression valve

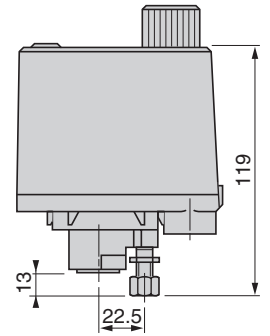

ØA = G 1/4 or G 3/8 (female)

(1) 2 tapped entries for n° 13 cable gland

(2) Minimum clearance zone for screwing-on pressure switch at point A

ØA = ØB = ØC = ØD = G 1/4 (female)

XMP●25●●●●●

Fluid connection G 1/4 or 4 x G 1/4 (female)
Without decompression valve

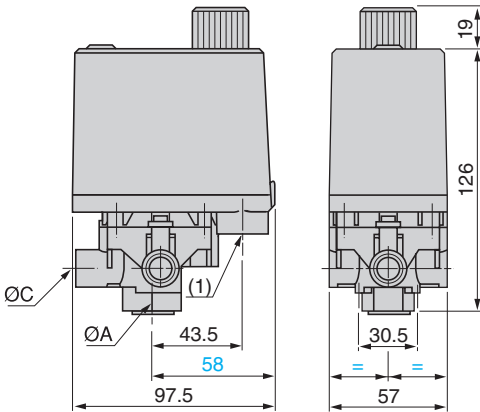

With straight, olive connection, decompression valve

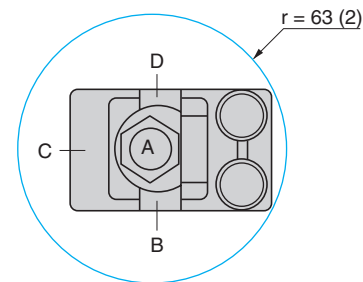
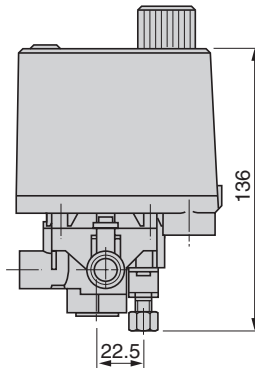

Fixing bracket XMAZL001

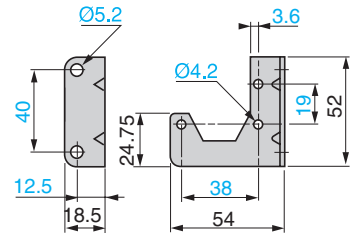

XMP●25●21●●: ØA only = G 1/4 (female)

XMP●25●24●●: ØA = ØB = ØC = ØD = G 1/4 (female)

(1) 2 tapped entries for n° 13 cable gland

(2) Minimum clearance zone for screwing-on pressure switch at point A

XMLC300E2S12	62	XMPA12B2242	99	XMXA12L2435	84
XMLC300N2S12	62	XMPA12C2131	98	XMXA25L2135	84
XMLC500D2S12	66	XMPA12C2242	99	XMXA25L2435	84
XMLC500N2S12	66	XMPA25B2131	100	XZCC43FCP40B	68
XMLCL35R2S12	28	XMPA25C2131	101		
XMLCL35S2S12	28	XMPB06B2131	96		
XMLCL35S2S13	28	XMPB06B2242	97		
XMLCM02T2S12	20	XMPB12B2131	98		
XMLCM02V2S12	20	XMPB12B2242	99		
XMLCM05B2S12	25	XMPB25B2131	100		
XMLCM05C2S12	25	XMPC06B2131	96		
XMLCS02B2S12	35	XMPC06B2242	97		
XMLCS02B2S13	35	XMPC06C2131	96		
XMLCS04B2S12	38	XMPC06C2242	97		
XMLCS10A2S12	42	XMPC12B2131	98		
XMLCS20A2S12	46	XMPC12B2242	99		
XMLCS35R2S12	28	XMPC12B2431	99		
XMLCS35R2S13	28	XMPC12C2131	98		
XMLD004B1S12	39	XMPC12C2242	99		
XMLD010B1S11	43	XMPC25B2131	100		
XMLD010B1S12	43	XMPC25C2131	101		
XMLD010C1S11	43	XMPD06B2131	96		
XMLD020B1S12	47	XMPD06B2242	97		
XMLD020B1S13	47	XMPD06C2131	96		
XMLD020C1S12	47	XMPD06C2242	97		
XMLD035B1S12	51	XMPD12B2131	98		
XMLD070D1S12	55	XMPD12B2242	99		
XMLD070D1S13	55	XMPD12C2131	98		
XMLD070N1S12	55	XMPD12C2242	99		
XMLD160D1S12	59	XMPD12C2431	99		
XMLD160D1S13	59	XMPE06B2131	96		
XMLD160E1S12	59	XMPE06C2131	96		
XMLD300D1S12	63	XMPE06C2242	97		
XMLD300D1S13	63	XMPE06C2431	97		
XMLD300E1S12	63	XMPE12B2131	98		
XMLD300N1S12	63	XMPE12B2242	99		
XMLD500D1S12	67	XMPE12B2431	99		
XMLDL35R1S12	29	XMPE12C2131	98		
XMLDM02T1S12	21	XMPE12C2242	99		
XMLDM02V1S12	21	XMPE12C2431	99		
XMLZA024	68	XMPMDR01	104		
XMLZA120	68	XMPR06B2133	102		
XMLZB024	68	XMPR06B2433	103		
XMLZB120	68	XMPR06C2133	102		
XMLZL001	68	XMPR06C2433	103		
XMLZL002	68	XMPR12B2131	98		
XMLZL003	68	XMPR12B2133	102		
	86	XMPR12B2433	103		
XMLZL004	68	XMPR12C2131	98		
XMLZL005	68	XMPR12C2133	102		
XMLZL006	68	XMPR12C2433	103		
XMLZL010	68	XMPR25B2131	100		
XMLZL011	68	XMPR25B2133	102		
XMLZL012	68	XMPR25B2433	103		
XMLZL013	68	XMPR25C2131	101		
XMLZL014	68	XMPR25C2133	102		
XMLZL015	68	XMPR25C2433	103		
XMLZZ024	68	XMPZ31	86		
XMLZZ120	68		104		
XMPA06B2131	96	XMPZ33	86		
XMPA06B2242	97		104		
XMPA06C2131	96	XMXA06L2135	84		
XMPA06C2242	97	XMXA06L2435	84		
XMPA12B2131	98	XMXA12L2135	84		

Schneider Electric Industries SAS

Head Office
35, rue Joseph Monier
F-92500 Rueil-Malmaison
France

www.tesensors.com

The information provided in this documentation contains general descriptions and/or technical characteristics of the performance of the products contained herein. This documentation is not intended as a substitute for and is not to be used for determining suitability or reliability of these products for specific user applications. It is the duty of any such user or integrator to perform the appropriate and complete risk analysis, evaluation and testing of the products with respect to the relevant specific application or use thereof. Neither Schneider Electric nor any of its affiliates or subsidiaries shall be responsible or liable for misuse of the information contained herein.

Design: Schneider Electric
Photos: Schneider Electric